

# Investigation to Reliability of Optical Communication Links using Auto-Track Subsystems in Presence of Different Beam Divergences

F. D. Kashani\*<sup>(C.A.)</sup>, M. R. Hedayati Rad\*\*, M. R. Mahzoun\*\*, E. Kazemian\*<sup>\*\*\*</sup> and A. Kahrizi\*

**Abstract:** In this paper, we investigate the effects of auto-tracking subsystem together with different beam divergences on SNR, BER and stability of FSO communication links. For this purpose we compute the values of power, SNR and BER on receiver, based on analytic formula of Gaussian beam on receiver plane. In this computation the atmospheric effects including absorption, scattering and turbulence are considered. Using mentioned computed values, the laser link stability and its reliability in presence of auto-tracking subsystems are evaluated. The results of simulation and computation are shown with the help of figures and tables.

**Keywords:** Atmospheric Turbulence, Auto-Tracking, Absorption and Scattering, FSO Laser Communication.

## 1 Introduction

In Free Space Optical (FSO) communication links, atmospheric phenomena including absorption, scattering and turbulence have significant impacts on the quality of the laser beam propagation through the channel. Absorption and/or scattering normally will result in optical losses, while turbulence contributes to the intensity scintillation, which can severely impair quality, and reliability of FSO links [1]. Design of current FSO systems is based on line-of-sight communication to transmit data, video, and voice up to a bandwidth of 2.5 Gbps [2]. To provide a line-of-sight connection, the transceivers are normally placed on high-rise buildings. However, dynamic wind loads, thermal expansion and weak earthquakes cause building swaying. These sways distort the transceivers alignments, causing pointing error, which its outcome is fading of the received signal [3]. To overcome this problem and maintain the link stability some systems use active beam tracking while some may set the divergence of the beam so that even in the case of beam

wobbling, the receiver remains in its field of view [4]. Auto-tracking refers to an automatic mechanism that continuously tweaks the orientation of the laser transmitter to compensate any unintended movement of the beam due to swaying of buildings or the turbulence-induced beam wandering [5]. Using auto-tracking subsystem in FSO links allow transmitters to use narrower divergence angle and less transmitting power. These subjects have significant influences on system optimization with characterizing beam propagation through ABCD system as its most important part. The effects of aperture ABCD system on propagation properties of laser beams are studied by many researchers [6-18]. However, almost all of them investigate the propagation properties without emphasizing on the divergence of laser source.

The quality of FSO links have been described by availability and BER, which are determined by the parameters of link and the statistical properties of the atmosphere [19, 20]. Although the transceiver's optics, atmospheric effects (absorption, scattering and turbulence) and auto-tracking subsystems have noticeable impacts on implicit parameters, to the best of our knowledge, almost none of the related researches consider the whole effects (together) on FSO link quality.

The purpose of this paper is to study the effects of auto-tracking subsystem and atmospheric losses on link quality. To achieve this goal, the current paper is organized as follows, firstly, we introduce an analytical formula for intensity distribution of Gaussian beams

Iranian Journal of Electrical & Electronic Engineering, 2014.

Paper first received 1 Feb. 2013 and in revised form 7 Oct. 2013.

\* The Authors are with the Department of Physics, Iran University of Science and Technology, Tehran, Iran.

\*\* The Authors are with the Department of Electronic Engineering, Imam Hosein University, Tehran, Iran.

\*\*\* The Author is with the Department of Science, Maritime University of Imam Khomeini, Nowshahr, Mazandaran.

E-mails: f\_dk@iust.ac.ir, mrheda@gmail.com, Rezamahzoun@yahoo.com, e\_kazemian@iust.ac.ir, and kahrizi64@gmail.com.

which propagates through a complete optical path including the optics of transmitter containing a collimator (designed for a given wavelength and some divergence angles) and a propagation path,  $L_2$ , by emphasizing on beam deviation due to environmental effects such as slight motion of buildings, atmospheric phenomena, wind and so on. Secondly, the atmospheric transmission and the receiving power are calculated based on the numerical method. Finally, the behavior of SNR and BER are studied for some different visibility conditions and beam divergence angles by considering auto-tracking system effects on communication link performance.

## 2 Propagation Equation of Gaussian Beams

Fig. 1-a shows the layout of an FSO systems transmitter. The transmitter consists of a circular laser diode source and an optical collimator that includes three thin lenses. It is worth mentioning to clarify, we use the collimator that has been designed by ZEMAX software and used in experimental setup for reducing divergence of the beam. To study the beam propagation through optical systems based on Collins method, an optical system can be approximated by a matrix known ABCD matrix. In our calculation, to form the ABCD matrix, three lenses are approximated by thin lenses. The optical receiver comprises an aperture and a convergent lens that focuses the received power (Fig. 1-b).

In calculation of intensity distribution, optical systems are approximated by ABCD matrix. Intensity distribution formula depends on ABCD matrix elements is introduced as follows:

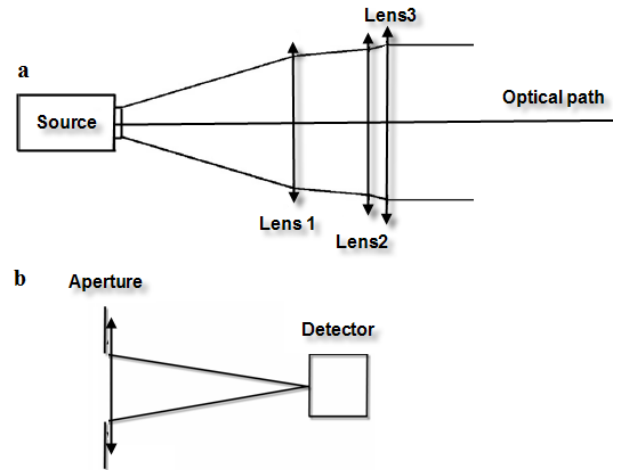
$$I(x, y, z) = \frac{A_0 A_0^* k_0^2 w_0^2}{B^2 d_3 w^2(z')} \exp\left(\frac{-2k_0^2((x-x_0)^2 + (y-y_0)^2)}{B^2 d_3 w^2(z')}\right) \quad (1)$$

$$d_3 = \frac{4}{w^4(z')} + k_0^2 \left(\frac{1}{F_0} - \frac{A}{B}\right)^2$$

where  $z'$  is distance from beam waist,  $w_0$ ,  $w(z')$  and  $F_0(z')$  are beam waist, measure of the beam width and wave front radius of curvature on the windows of laser, respectively [11, 21].

Continuous power emitted by laser diode is supposedly stable resulting in  $A_0$  to be a constant value.

$k_0 = \frac{2\pi}{\lambda_0}$  is the wave number,  $\lambda_0$  is the wavelength, A, B, C and D are transfer matrix elements of aligned optical systems. Transfer matrix elements are function of  $z$  (the propagation path length).  $x_0$  and  $y_0$  are the amount of beam deviation in x and y directions, respectively. Considering this fact that only some part of the receiving power can reach the detector, the received power must be calculated over a circular area with radius "a" as Eq. (2) [21].



**Fig. 1** (a) The layout of collimator  $A = 0.735$ ,  $B = 0.0098$ ,  $C = -72.416$ ,  $D = 0.399$  (b) Schematic layout of optical receiver (lens, aperture and detector).

$$P_a = \int_{-a}^a \int_{-\sqrt{a^2-x^2}}^{\sqrt{a^2-x^2}} I(x, y, z) dy dx \quad (2)$$

where  $I(x, y, z)$  is intensity distribution in  $(x, y, z)$ . Substituting Eq. (1) in Eq. (2), the power on the surface of optical receiver can be calculated numerically. In this calculation, the atmospheric effects and optical losses have not been included.

To have an appropriate link budgeting, it is necessary to apply transmission function of atmosphere and optical systems to our link. In sections 3 and 4 the atmospheric transmission function due to absorption, scattering and atmospheric turbulence are calculated separately.

## 3 Atmospheric Optical Transmission

Beer's law describes the attenuation of light traveling the atmosphere due to both absorption and scattering. In general,  $T_{A-S}$ , the transmission of radiation in the atmosphere is given by Beer's law, as a function of distance as bellows [7, 22]:

$$T_{A-S}(R) = \frac{P(R)}{P(0)} = e^{-\sigma R} \quad (3)$$

where  $P(R)$  is the detected power at the location R,  $P(0)$  is initially launched power,  $T_{A-S}$  is atmospheric transmission and  $\sigma$  is the attenuation or total extinction coefficient (per unit length). The attenuation is given as [23, 24]:

$$\sigma = \frac{3.91}{V} \left( \frac{\lambda}{550 \text{ nm}} \right)^{-q} \quad (4)$$

where

$V$  = visibility (in km)

$\lambda$  = Wavelength (in nm)

$q$  = size distribution of the scattering particles:

- = 1.6 for high visibility ( $V \geq 50$  km)
- = 1.3 for average visibility ( $6 \text{ km} \leq V < 50$  km)
- =  $0.16V + 0.34$  for haze visibility ( $1 \text{ km} \leq V < 6$  km)
- =  $V - 0.5$  for mist visibility ( $0.5 \text{ km} \leq V < 1$  km)
- = 0 for fog visibility ( $V < 0.5$  km)

Some weather conditions and precipitation along with their visibility and transmission coefficient are collected in Table 1.

**Table 1** A number of weather conditions and precipitation along with their visibility and transmission coefficients.

Weather condition	V [km]	T [dB/km]
Very clear	50	-0.06
Clear	20	-0.22
Light mist	10	-0.44
Light rain and snow	5.9	-0.96

#### 4 Influence of Turbulence on Optical Transmission

Atmospheric turbulence is another important atmospheric channel degrading factor, causes random fluctuation in the intensity of the optical radiation [9, 25]. Atmospheric turbulence has been studied extensively by many authors and various theoretical models have been proposed to describe its function [26, 27]. In some of these methods, turbulence extent is evaluated with the help of the structural parameter of the index of refraction and optical variance. Optical variance of Gaussian beam in weakly turbulence atmosphere can be expressed as follows [9]:

$$\sigma_i^2(r, L_2) = 4.42\sigma_R^2\Lambda^{5/6}\frac{r^2}{W^2} + 3.86\sigma_R^2 \times \left\{ 0.4 \left[ (1+2\Theta)^2 + 4\Lambda^2 \right]^{5/12} \cos \left[ \frac{5}{6} \tan^{-1} \left( \frac{1+2\Theta}{2\Lambda} \right) \right] - \frac{11}{16} \Lambda^{5/6} \right\} \quad (5)$$

in which

$$\sigma_R^2 = 1.23C_n^2 k^{7/6} L_2^{11/6}, \Lambda_0 = \frac{2L_2}{k_0 w_{01}^2}, \Theta_0 = 1 - \frac{L_2}{F_{01}},$$

$$\Lambda = \frac{\Lambda_0}{\Theta_0^2 + \Lambda_0^2}, \Theta = \frac{\Theta_0}{\Theta_0^2 + \Lambda_0^2}, \alpha = \frac{\alpha_0 D - iC}{A + i\alpha_0 B},$$

$$w_{01} = \sqrt{\frac{2}{\text{Re}(k_0 \alpha)}}, F_{01} = \frac{1}{\text{Im}(\alpha)}, W = w_{01} \sqrt{\Theta_0^2 + \Lambda_0^2}$$

$$\alpha_0 = \frac{2}{k_0 w^2(z')} + \frac{i}{F_0},$$

where  $\sigma_i^2$  and  $\sigma_R^2$  are scintillation index and Rytov scintillation index, respectively.  $\Lambda/\Lambda_0$  and  $\Theta/\Theta_0$  are Fresnel ratio and curvature parameter at output/input plane,  $r$  is radial distance from the beam center line and  $W$  is beam width at output plane (on input plane of the receiver without considering the effects of turbulent atmosphere).  $w_{01}$  and  $F_{01}$  are beam width and phase front curvature of the wave at the input plane (in the exit plane of transmitter).  $\alpha_0$  is a complex parameter related to spot size and phase front radius of curvature.  $\alpha$  is a

complex parameter related to beam parameters at input plane and ABCD transfer matrix elements.  $L_2$  Indicates the propagation path length (separation distance between transmitter and receiver).

For weak turbulence conditions ( $\sigma_i^2 < 1$ ), it is possible to use an approximate formula to estimate the atmospheric transmission function [19]:

$$T_{turb} = 1 - \sqrt{\sigma_i^2} \quad (6)$$

Therefore, the total optical transmission of the FSO communication link path can be calculated as follows:

$$T_{total} = T_{A-S} T_{Opt} T_{turb} \quad (7)$$

where  $T_{Opt}$  is transmission of optical elements (lenses of transmitter and receiver).

#### 5 Some Useful Communication Link Parameters

Signal to Noise Ratio (SNR) can be given as follows:

$$SNR = \frac{P_R}{P_{n0}} \quad (8)$$

where  $P_R$  and  $P_{n0}$  are the power of signal and noise received on detector, here we consider noise power to be equal to detector's NEP (Noise Equivalent Power).  $P_R$  is calculated as bellows:

$$P_R = P_a T_{total} \quad (9)$$

where  $T_{total}$  is the total optical path transmission and  $P_a$  is the received power at the receiver's aperture plane without considering atmospheric effects, based on Eq. (2).

The parameter BER for OOK modulated signal is a function of SNR and can be expressed as bellows [9]:

$$BER = \frac{1}{2} \text{erfc} \left( \frac{1}{2\sqrt{2}} \sqrt{SNR} \right) \quad (10)$$

Another useful parameter, which characterizes the turbulence effects on optical power, is Strehl Ratio. Strehl Ratio can be defined as follow [28]:

$$\text{Strehl Ratio} = \frac{I_{\max \text{ Atm}}}{I_{\max \text{ free space}}} \quad (11)$$

where  $I_{\max \text{ Atm}}$  and  $I_{\max \text{ free space}}$  are the maximum intensities arrive at the receiver plane (axial point) after propagating through atmosphere and through free space, respectively. Eqs. (8), (10) and (11) are the basis of results, which will be explained in the next sections.

#### 6 Results and Discussion

In this section based on the presented analysis, the effect of beam swaying on BER and SNR of an FSO system together with the role of adding auto-tracking section are simulated.

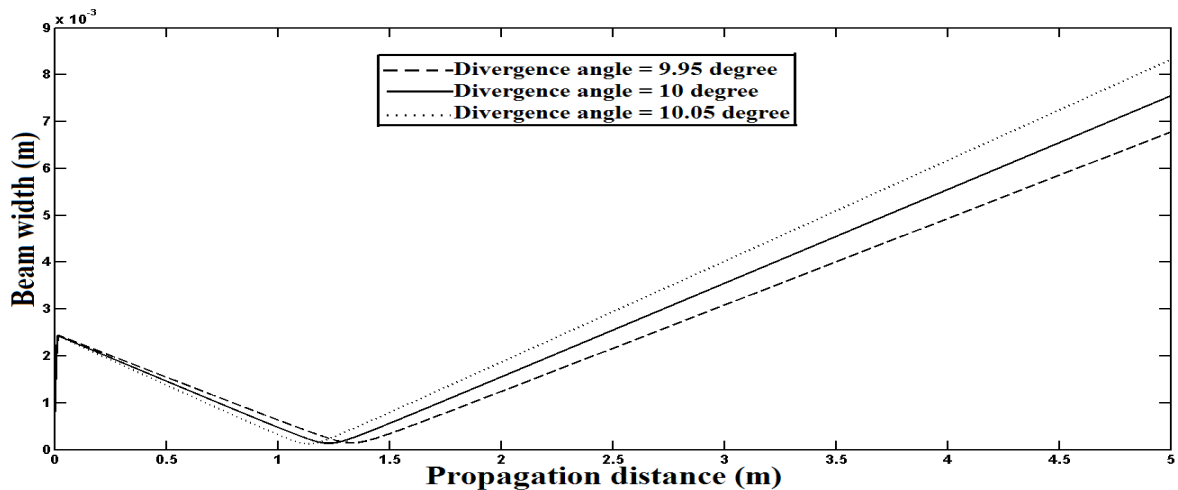


Fig. 2 Beam width variation versus propagation path length. Collimator-source separation ( $L_0$ ) is 9.352 mm.

The considered beam swaying can be due to different atmospheric conditions or system mount's vibration. The source we used in our simulation is a circular laser diode ( $\lambda = 850\text{ nm}$ ) that has 0.45 mm beam width on the laser's window. As Fig. 1 shows the collimator is an optical system which is designed to reduce the laser beam divergence. The initial divergence angle of the practice beam is 10 degrees while the divergence angle of the outcome beam depends on the source-collimator separation distance.

In order to describe and analyze the effect of adding an auto-tracking subsystem to FSO links, we consider two situations: the first one explains the analysis for a normal FSO link and the second one describes an FSO link with auto-tracked subsystem.

### 6.1 FSO Link without Auto-Tracking

In this section, to investigate the effects of environment on the intensity distribution and the amount of optical power at the receiver plane, and also to evaluate the effect of source divergence on link quality, a semiconductor laser source with  $10 \pm 0.5^\circ$  divergence angle is considered. By varying the beam divergence on collimator output and under following condition,  $C_n^2 = 10^{-15} \text{ m}^{-2/3}$ ,  $V = 10 \text{ km}$ ,  $P = 100 \text{ mW}$ , the receiver obtained power, SNR and BER will vary in accordance with the values recorded in Table 2. The source locates in the distance of 9.352 mm from the collimator input.

Divergence angle of collimator output beam can be changed by variation of initial beam divergence angle. Beam divergence angle variation causes some changes in beam waist size and location as shown in Fig. 2.

Beam width can be calculated based on  $e^{-1}$  method. In this method,  $W$  denotes the radius at which the field amplitude is  $e^{-1}$  of its maximum value as shown in Fig. 3.

According to above mentioned calculation, any change in initial beam divergence causes variation in spatial broadening which leads to variation in received power and SNR. As mentioned in Eq. (1) intensity is a function of  $x_0$  and  $y_0$ , vary with time during operation due to building swaying and beam wandering. The parameters SNR and BER will vary with times, as they are function of power and consequently intensity. When the beam divergence is fixed, the lack of stability in the mechanical system, variation in temperature, building swaying due to wind and so on, cause the BER to vary.

Table 2 Received power, SNR and BER for three different divergence angles for aligned transceiver system.

$\theta_0$ [degree]	$\theta_{\text{out}}$ [mrad]	$P_R$ [W]	SNR	BER
9.95	1.85	$4.99 \times 10^{-7}$	166.36	-10
10	2.00	$4.26 \times 10^{-7}$	141.91	-9
10.5	2.15	$3.67 \times 10^{-7}$	122.49	-8

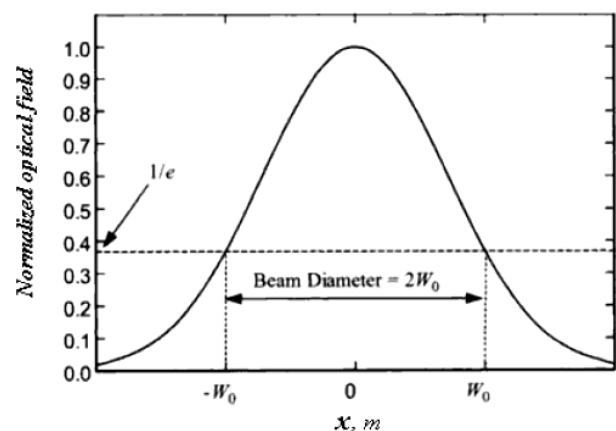
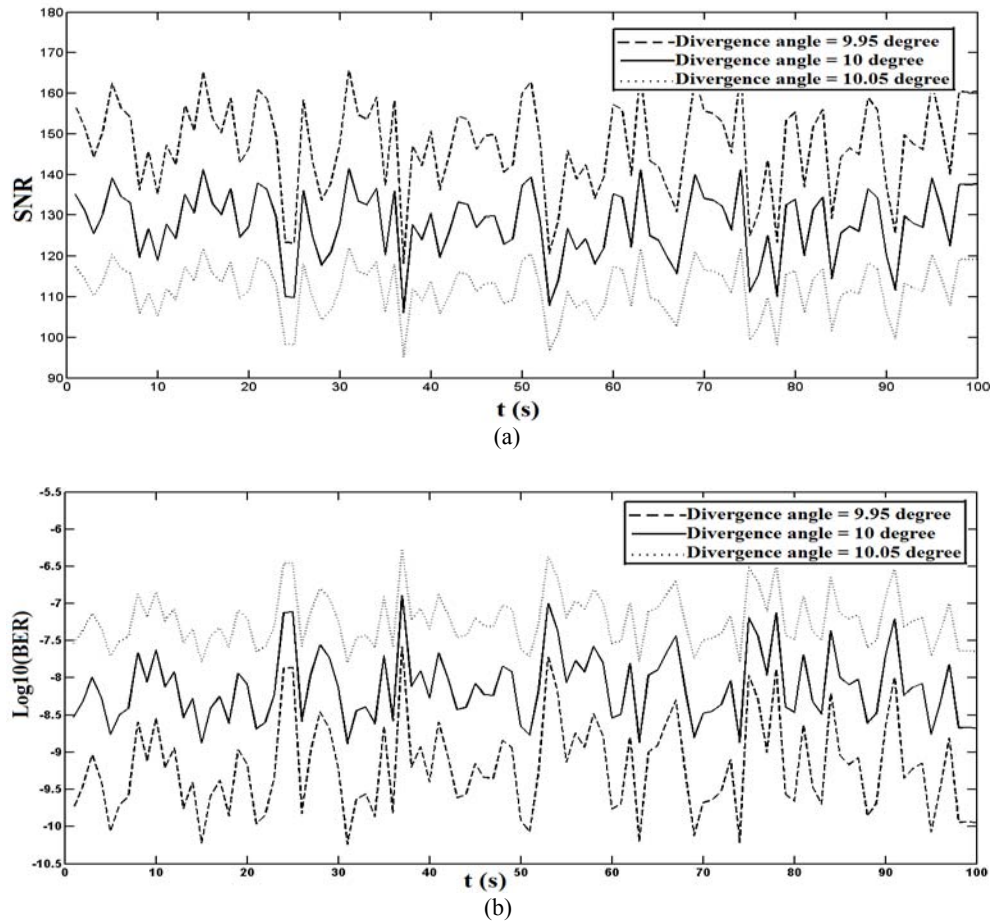


Fig. 3 Amplitude profile of a Gaussian beam wave [9].



**Fig. 4** (a) effect of beam deviation (in the range of  $\pm 3$  m) on SNR, (b) BER for three different resulting beam divergence angles (1.85, 2, 2.15 mrad) due to initial beam divergence variation.

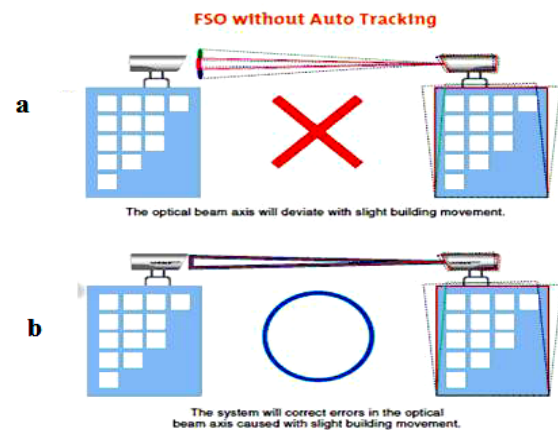
Fig. 4 shows the effects of beam deviation on SNR and BER in range between beam optical axis and the location which intensity reaches to 83% of its maximum value (about  $\pm 3$  m around optical axis in beam cross-section). These graphs are plotted for 5 km distance and three different divergence angles (9.5, 10 and 10.5 degree) under the same condition, show SNR and BER versus time.

As it is shown, increasing the beam divergence causes SNR to fall and BER to grow. Moreover, beam deviation leads to fluctuations in SNR and BER during data transformation. Using active auto-tracking systems can almost correct the errors in the optical beam axis caused by slight building movement (as shown in Fig. 5).

## 6.2 Auto-Tracked FSO Link

To overcome beam deviation effects due to building swaying and so on, almost all of the long-range (about 5 km and more) commercial FSO systems use auto-tracking subsystems. By using auto-tracking subsystem, transmission of data can be done with less BER and more availability while the beam divergence and initial optical power can be reduced [4].

In our simulation for this kind of link we assume the laser beam has the basic divergence of 10 degree and source-collimator distance is 9.289 mm. Also for auto-track subsystem two intrinsic errors ( $\pm 0.5$  m and  $\pm 1$  m in distance of 5 km) are considered. With the above assumption, we analyze and summarize the results in Table 3. Here, the initial optical power is set to 50 mW.



**Fig. 5** Schematic representation of the auto-tracking subsystem effect, canon company.

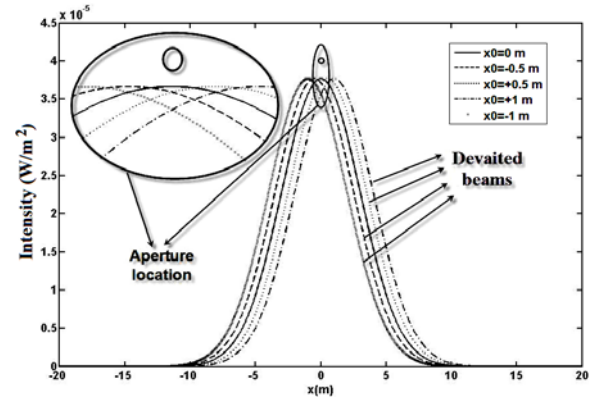
**Table 3** Received power, SNR and BER values for three different divergence angles for aligned transceiver system with auto-tracking subsystem.

$\theta_0$ [degree]	$\theta_{out}$ [mrad]	$P_R$ [W]	SNR	BER
9.95	1.04	$7.82 \times 10^{-7}$	260.62	-15
10	1.2	$5.92 \times 10^{-7}$	197.19	-12
10.5	1.36	$4.63 \times 10^{-7}$	154.35	-10

As it is clear from Table 3, in this case, decreasing the beam divergence angle (due to essence of auto-tracking subsystem) causes the growth of SNR and fall of BER, while the initial power decreases.

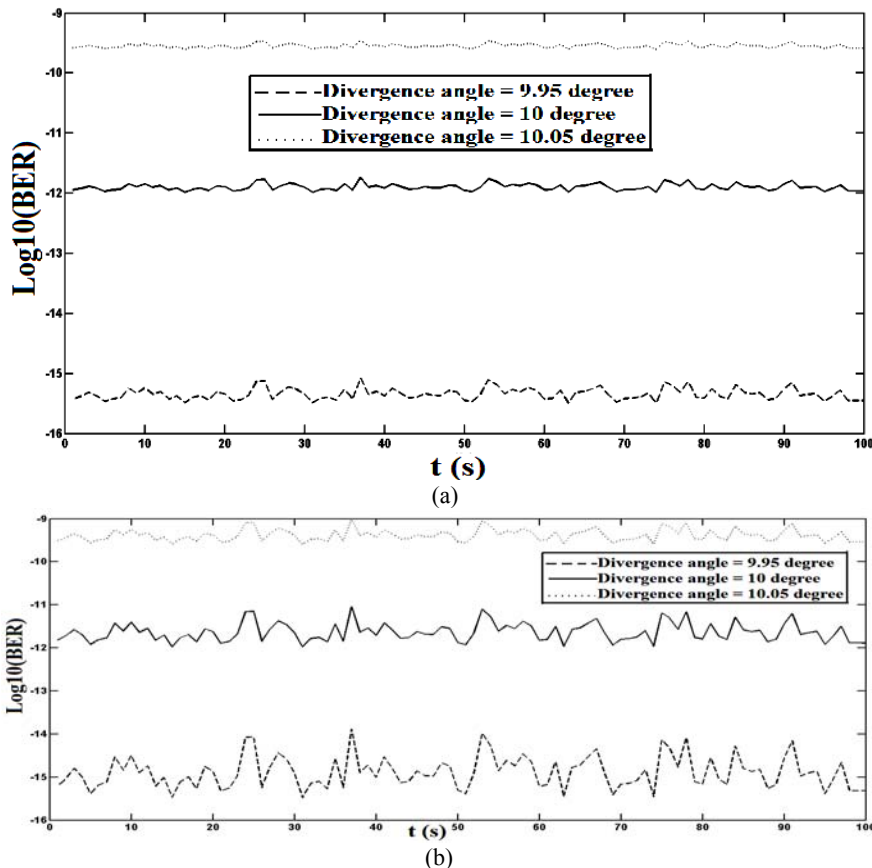
Fig. 6 shows beam intensity distribution on the input plane of the receiver. As it is shown, Beam deviation causes variation in the amount of power received on detector.

Fig. 7 shows BER for beam deviation in range of  $\pm 0.5$  m and  $\pm 1$  m. In this figure, the divergences angles are 1.04, 1.2, 1.36 mrad, the initial optical power is 50 mW, and the other conditions are the same as those which are in Fig. 4.



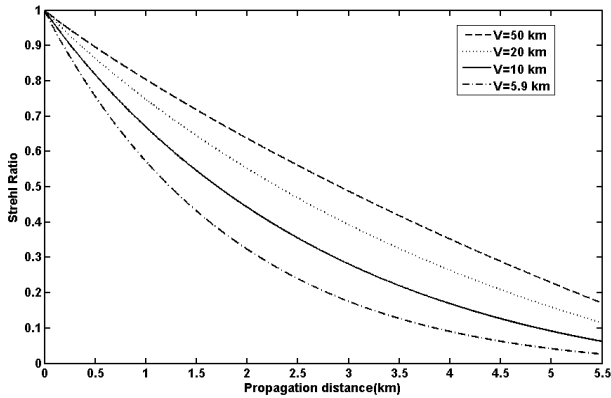
**Fig. 6** Intensity distribution and receiver aperture situation for four different deviation values ( $x_0 = \pm 0.5, \pm 1$  m).

As it is expected, increasing the beam divergence causes the BER to grow. It is evident that any increase in intrinsic auto-tracking system error, increases the BER values. As it is shown, beam deviation dictated fluctuations of BER values that increase with further growth of beam deviation range. Nevertheless, because of using auto-tracking system, these fluctuations are smoother than without-auto-tracking subsystems' shown in Fig. 4.

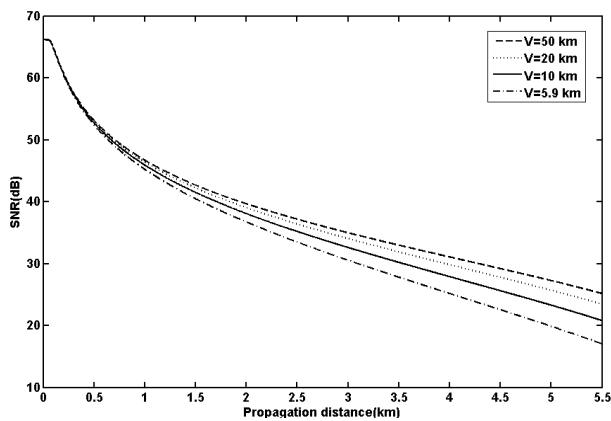


**Fig. 7** BER for three different resulting divergence angles (1.04, 1.2, 1.36 mrad) due to source divergence angle variation, (a) the effect of beam deviation in the range of  $\pm 0.5$  m (b) the effect of beam deviation in the range of  $\pm 1$  m.





**Fig. 8** Strehl ratio values versus propagation path length for different visibility values (divergence angle=1.2 mrad).



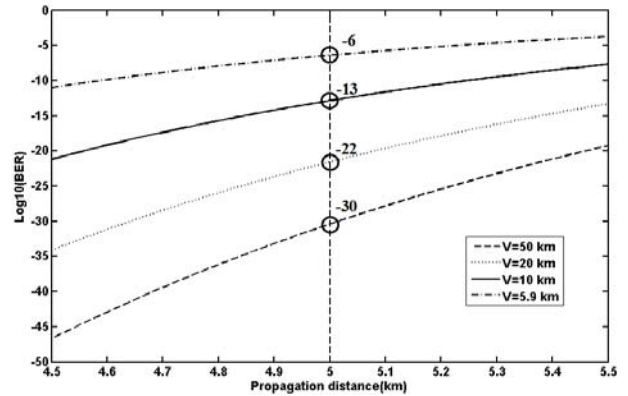
**Fig. 9** SNR values versus propagation distance for four different visibility values (divergence angle = 1.2 mrad).

As mentioned above, this system is designed to operate in  $V = 10$  km condition with reliable communication and availability. So it is necessary to study the effects of visibility condition on link quality factors. The influences of atmospheric conditions on maximum optical intensity are studied. The result of this investigation is shown in Fig. 8.

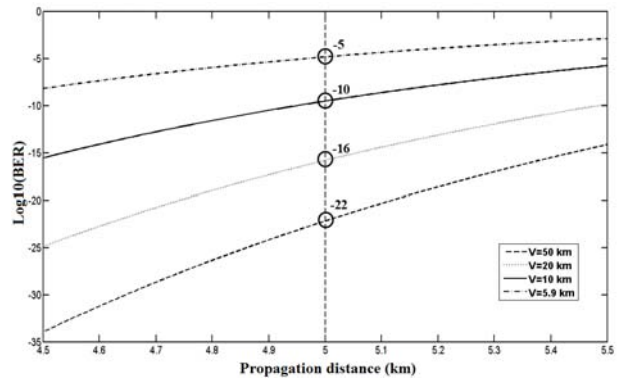
It is clear that any reduction in visibility coefficient (due to aerosols and atmospheric molecules compression) causes the maximum intensity value and Strehl Ratio to decline. These behaviors signify that visibility diminishing and propagation-path-length raising cause received optical power to fall, which it is the main reason of SNR reduction.

Fig. 9 shows SNR values versus propagation distance for different visibility. Less visibility causes less SNR while the rate of variation is more intensive in smaller visibility coefficient.

Fig. 10 shows BER variation versus propagation path length for different weather conditions for system without auto-tracking subsystem and auto-tracked FSO link. Although the system is designed to operate in  $V = 10$  km, according to Fig. 10-a, the system is able to operate in some adverse weather conditions such as  $V = 5.9$  km with acceptable reliability ( $BER = 10^{-6}$ ) by using auto-tracking subsystem.



(a)



(b)

**Fig. 10** (a) The effect of weather conditions on BER (divergence angle = 1.2 mrad) using auto tracking subsystem (b) BER values versus propagation distance for four different weather conditions (divergence angle = 1.8 mrad and  $P_0 = 100$  mW) - no auto-tracking exist.

However, if there is no an active auto-tracking subsystem, BER value will increase to  $10^{-5}$  and so the link is not reliable (Fig. 10-b). To the best of our knowledge, our results have a good agreement with data of manufactures of FSO links.

## 7 Conclusions

Accurate design of the optical transmitter, using laser diodes with precise initial divergence angles, the idea of using auto-tracking subsystem to compensate transceiver head swaying and their effects on link quality factors such as BER and availability are significant matters. In this paper, the effects of using auto-tracking subsystem and variation of beam divergence on the BER and SNR of FSO communication system are analyzed. As the main research for this paper, we investigated the effects of auto-tracking subsystem on link reliability. It is shown using auto-tracking subsystem can be lead to capability of using sources with lower divergence angles and initial powers while improving SNR, BER and consequently the availability. It is described how the idea of adding auto-tracking subsystem to our links can lead to more reliable communications.

## References

- [1] A. Prokes, "Atmospheric effects on availability of free space optics systems", *Optical Engineering*, Vol. 48, No. 6, pp. 066001-10, 2009.
- [2] A. C. Gabriel, H. R. Hakki and J. S. James, "Optical tracking and auto-alignment transceiver system", *IEEE A & E Systems Magazine*, Vol. 25, No. 9, pp. 26-34, 2010.
- [3] Sh. Arnon, "Effects of atmospheric turbulence and building sway on optical wireless-communication systems", *Optics Letters*, Vol. 28, No. 2, pp. 129-131, 2003.
- [4] H. Willebrand and B. S. Chuman, *Free-Space optics: Enabling optical connectivity in today's networks*, SAMS, Indianapolis, USA, 2002.
- [5] B. Chen, *A trial based study of free space optics systems in Singapore*, Agilent technology, Singapore, 2002.
- [6] G. Zhao, X. Ji and B. Lü, "Approximate analytical equations of Gaussian beams through hard aperture optics", *Optik*, Vol. 114, No. 6, pp. 241-245, 2003.
- [7] S. A. Collins Jr., "Lens-system diffraction integral written in terms of matrix optics", *J. Opt. Soc. Am.* Vol. 60, No. 9, pp. 1168-1177, 1970.
- [8] A. E. Siegman, *Laser, University Science Books*, Hill Valley, California, USA, 1986.
- [9] L. C. Andrews and R. L. Phillips, *Laser beam propagation through random media*, SPIE optical Engineering press, A publication of SPIE, The international Society for optical engineering, Bellingham, Washington USA, 1998.
- [10] M. R. Hedayati Rad, F. D. Kashani, M. M. Eftekhari and M. R. Mahzoun, "Characterizing the divergence properties of the laser diode beams propagation through collimator and aperture ABCD optical system", *Optics & Laser Technology*, Vol. 42, No. 8, pp. 1269-1275, 2010.
- [11] F. D. Kashani, M. R. Hedayati Rad, M. A. R. Hedayati Rad and M. R. Mahzoun, "Reliability analysis of the auto-tracked FSO communication links", *Fifth Int. Symposium on Telecommunications with emphasis on Information and Communication Technology*, pp. 4-6, 2010.
- [12] J. J. Wen and M. A. Breazeale, "A diffraction beam field expressed as the superposition of Gaussian beams", *J. Acoust. Soc. Amer.*, Vol. 83, No. 5, pp. 1752-1756, 1988.
- [13] N. Zhou, G. Zeng and L. Hu, "Algorithm for flattened Gaussian beams passing through aperture and unapertured paraxial ABCD optical systems", *Optics Communications*, Vol. 240, No. 4, pp. 299-306, 2004.
- [14] Y. Cai, X. Lü, H. Eyyuboğlu and Y. Baykal, "Paraxial propagation of a partially coherent flattened Gaussian beam through aperture ABCD optical systems", *Optics Communications*, Vol. 281, No. 12, pp. 3221-3229, 2008.
- [15] Y. Cai and L. Hu, "Propagation of partially coherent twisted anisotropic Gaussian-Schell model beams through an apertured astigmatic optical system", *Optics Letters*, Vol. 31, No. 6, pp. 685-687, 2006.
- [16] Q. Lin and Y. Cai, "Tensor ABCD law for partially coherent twisted anisotropic Gaussian-Schell model beams", *Optics Letters*, Vol. 27, No. 4, pp. 216-218, 2002.
- [17] Z. Mei, D. Zhao and J. Gu, "Comparison of two approximate methods for hard-edged diffracted flat-topped light beam", *Optics Communications*, Vol. 267, No. 1, pp. 58-64, 2006.
- [18] D. Zhao, H. Mao, W. Zhang and Sh. Wang, "Propagation of off-axial Hermite-cosine-Gaussian beams through an apertured and misaligned ABCD optical system", *Optics Communications*, Vol. 224, No. 1, pp. 5-12, 2003.
- [19] R. Kvicala, V. Kevicera, M. Grabner and O. Fiser, "BER and availability measured on FSO link", *Radio Engineering*, Vol. 16, No. 3, pp. 7-12, 2007.
- [20] B. Ghafary, F. D. Kashani and E. Kazemian, "Reliability analysis of FSO communication links using aberrated divergent rectangular partially coherent flat-topped beam", *Iranian Journal of Electrical & Electronic Engineering*, Vol. 9, No. 1, pp. 13-19, 2013.
- [21] B. E. A. Saleh and M. C. Teich, *Fundamentals of photonics*, Second Edition, Wiley series in pure and applied, USA, 2007.
- [22] F. D. Kashani, E. Kazemian and M. Reza Hedayati Rad, "Analyzing the Propagation Behavior of a Gaussian Laser Beam through Seawater and Comparing with Atmosphere", *Iranian Journal of Electrical & Electronic Engineering*, Vol. 9, No. 4, pp. 197-203, 2013.
- [23] O. Bouchet, H. Sizun, C. Boirobert, F. de Fornel and P. Favenc, *Free-Space optics propagation and communication*, ISTE, London, UK, 2004.
- [24] I. I. Kim, B. McArthur and E. Korevaar, "Comparison of laser beam propagation at 785 nm and 1550 nm in fog and haze for optical wireless communications", *Proceedings of the SPIE*, pp. 4214-4226, 2001.
- [25] W. Popoola, Z. Ghassemlooy, M. S. Awan and E. Leitgeb, "Atmospheric channel effects on terrestrial free space optical communication links", *ECAI 2009 Int. Conference, 3rd edn, Electronics, Computers and Artificial Intelligence*, Pitesti, Romania, July, pp. 17-23, 2009.
- [26] X. Zhu and J. M. Kahn, "Free-space optical communication through atmospheric turbulence channels", *IEEE Transactions on*



*Communications*, Vol. 50, No. 8, pp. 1293-1300, 2002.

- [27] M. Born and E. Wolf, *Principles of Optics*, 7th Edition, University Press, Cambridge, UK, 1999.
- [28] A. E. Siegman, "How to (maybe) measure laser beam quality", *OSA Trends in Optics and Photonics Series*, Vol. 17, pp. 188-199, 1998.



**Fatemeh Dabbagh Kashani** was born in September 1981 in Tehran. She got her B.Sc. and M.Sc. and Ph.D. in physics from Iran University of Science and technology. Her Current research includes optical communication, wave propagation, adaptive optics and coherent imaging systems. Now she is assistant professor in Iran University of

Science and technology.



propagation, optical systems.

**Esmail Kazemian** was born in February, 1971 in Tehran. He got his B.Sc. in physics from Tabriz University and M.Sc. in physics from Amirkabir University of Technology (Tehran Polytechnic). Now, he is Ph.D. student at physics Department of Iran University of Science and technology. His Current research includes wave communication and coherent imaging



**Amir Kahrizi** was born in 1985 in Kermanshah, Iran. He received his B.Sc. degree in physics from the Buali-Sina University, Hamedan, Iran, and the M.Sc. degree in photonics from the Iran University of Science and Technology, respectively. Now he works on optical designing of free space optical communication systems.