

Nonlinear model of tape wound core transformers

Amir Baktash, Abolfazl Vahedi

Centre of Excellence for Power System Automation and Operation

Electrical Eng. Department, Iran University of Science & Technology

Narmak, Tehran, Iran

ABaktash@ee.iust.ac.ir, AVahedi@iust.ac.ir

Abstract: Recently tape wound cores, due to their excellent magnetic properties, are widely used in different types of transformers. Performance prediction of these transformers needs an accurate model with ability to determine flux distribution within the core and magnetic loss. Spiral structure of tape wound cores affects the flux distribution and always cause complication of analysis. In this paper, a model based on reluctance networks method is presented for analysis of magnetic flux in wound cores. Using this model, distribution of longitudinal and transverse fluxes within the core can be determined. To consider the nonlinearity of the core, a dynamic hysteresis model is included in the presented model. Having flux density in different points of the core, magnetic losses can be calculated. To evaluate the validity of the model, results are compared with 2-D FEM simulations and also a transformer designed for series-resonant converter and simulation results are compared with experimental measurements. Comparisons show accuracy of the model beside simplicity and fast convergence.

Key words: Hysteresis loop model, Nanocrystalline tape, Reluctance networks method, Series-resonant converter and Tape wound core.

1. Introduction

Tape wound core applications grow rapidly due to their excellent magnetic characteristics. These applications include a wide range of frequency and power from line-frequency to high frequency and from fraction of watt to hundreds of kilowatts. Power transformers, current transformers and pulse transformers are some of these applications. Determination of core loss, no-load current, inrush current and efficiency of the transformers needs a precise model of the core. In a solid toroidal core, circumferential magnetic field H linearly decreases from inside radius to outside radius of the core due to increase in magnetic path length and makes a corresponding change in flux density. Tape wound cores are made from high permeability magnetic strip alloys such as Nanocrystalline metals, amorphous metals or Si-Fe with thickness of about 18 - 100 μm . The spiral nature of these cores leads to a complex distribution of flux density [1]. In a wound core in addition of the fluxes along the tape (longitudinal flux) there are also fluxes perpendicular to the tape (transverse flux) that pass from one turn of tape to another turn through the gap (fig. 1). The behavior of transverse flux causes an extra eddy loss and makes a natural gap in the structure of the core [2]. Additionally, passing of the fluxes through the gap in the first and last turns of the core leads to big variations in longitudinal fluxes. Due to the complexity of the geometry, so far no analytical model has been presented for these cores and there are just few attempts to model using finite-elements method (FEM) in [1, 2] or measurements [3, 4]. Very low thickness of the ferromagnetic tapes and coating insulator with respect to the diameter of the core also asymmetrical geometry of the core lead to a demanding meshing of spiral turns and therefore make FEM simulations very time-consuming even in 2-D mode.

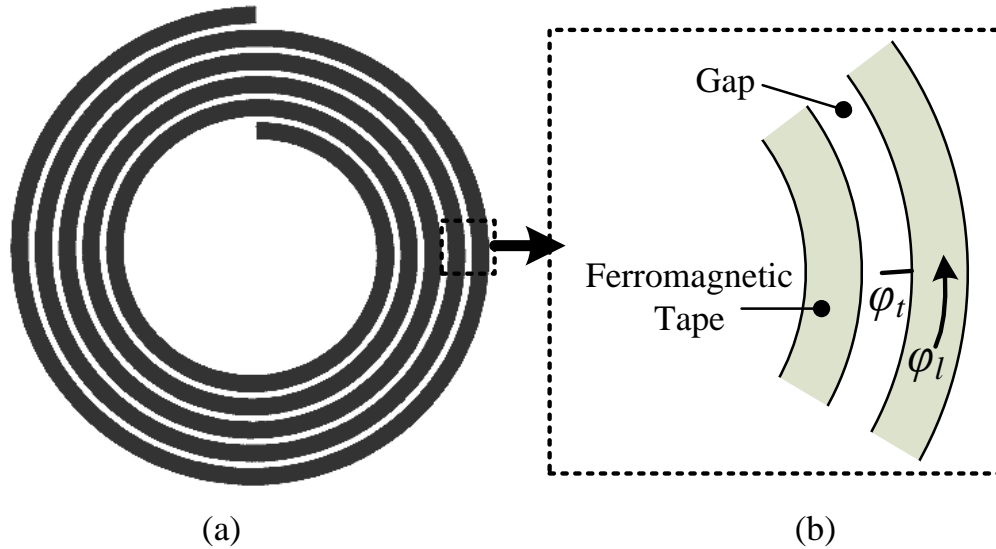

Figure 1. The structure of a toroidal wound core (a) and the longitudinal and transverse flux in the tape and gap (b)

In this paper, reluctance networks method (RNM) is applied for modeling and simulating of the tape wound cores. The model can determine distribution of the flux density and calculate core loss of transformer. 2-D FEM is used to verify the results of simulations. Additionally, the nonlinearity of the core is considered by using a dynamic hysteresis model. Finally, the results are compared with experiments. Simplicity, fast convergence and good accuracy are the main advantages of this model.

2. Reluctance network modeling

Reluctance network method is based on the analogy between electric and magnetic quantities, relations and on the dividing of the magnetic circuit in flux tubes. A reluctance is defined for each flux tube to form the network [5, 6]. Magnetic Kirchhoff's Laws for nodes and meshes and Ohm's law for magnetic circuit are used to solve the network. A significant saving in computing time and effort may be achieved by using this method especially for complicated geometries [7].

2.1. Implementation of reluctance networks

To implement a 2-D reluctance network model for a tape wound core, ferromagnetic tape and the gaps are divided into multiple elements. Each element in tape consists of an mmf source F_i and a linear (or nonlinear) reluctance R_{li} that conducts the longitudinal flux. Elements in gap just have a linear reluctance R_{lj} that allows passing of the transverse flux. Figure 2 shows the presented RNM of tape wound core and its partitioning. The tape reluctances are calculated as follows.

$$R_{li} = \frac{l_{li}}{\mu_0 \cdot \mu_r(B_i) \cdot A_l} \quad (1)$$

Where l_{li} is the length of element i in the tape and A_l is the area of tape elements. Relative permeability of each element of tape $\mu_r(B_i)$ in nonlinear modeling is a function of flux density of element and is calculated from hysteresis model. Assuming the uniform distribution of the winding around the core, the mmf F_i is equals to NI/n . where N is number of winding turns, I is the current of winding and n is number of elements in a turn of tape.

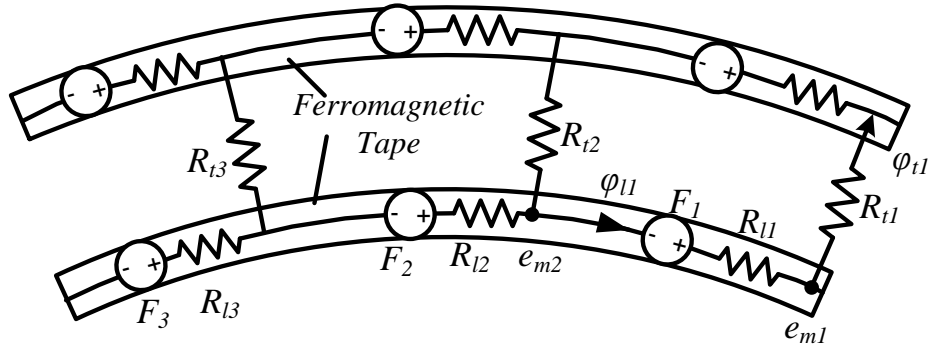

Figure 2. Presented RNM of a wound core

Due to very low thickness of the tapes for a wide range of frequencies, skin depth is sufficiently large and can be ignored. Therefore, the reluctances are independent of frequency. However, the equivalent thickness of elements can be used to apply the skin effect on the reluctances as (2).

$$R_{li} = \frac{l_{ji}}{\mu_0 \cdot \mu_r(B_i) \cdot A_l} \frac{\beta \cdot d / 2}{\tanh(\beta \cdot d / 2)} \quad (2)$$

Where $\beta^2 = j\omega\sigma\mu$, d is thickness of tape, σ is conductivity of tape and ω is angular frequency of excitation.

2.2. Dynamic Hysteresis model

To increase accuracy of the model, the nonlinear behavior of the core is considered by using a dynamic hysteresis model. This model is based on a static hysteresis model and magnetic viscosity and presents the applied field H as sum of static hysteresis field $H_{st}(B)$, classical field H_{class} and excess field H_{exc} as follows [8, 9]:

$$H = H_{st}(B) + H_{class} + H_{exc} \quad (3)$$

Where $H_{st}(B)$ is calculated from the static hysteresis loop for each value of B , H_{class} is extracted from well-known formula for classical loss in a thin ferromagnetic sheet and H_{exc} models the viscous behavior of excess loss in ferromagnetic material. Equation (4) presents the model in detailed form:

$$H = H_{st}(B) + \frac{t^2 \cdot \sigma}{12} \frac{dB}{dt} \frac{3(\sinh \lambda - \sin \lambda)}{\lambda(\cosh \lambda - \cos \lambda)} + \delta \cdot g(B) \left| \frac{dB}{dt} \right|^{1/\alpha} \quad (4)$$

Where t is thickness of sheet, $\lambda = d\sqrt{\pi\sigma\mu f}$, δ is sign function of dB/dt , $g(B)$ is a constant or function of B and controls shape of dynamic loop and α determines frequency properties of the model that the last two parameters should be extracted from measurements

Applied static model is a simplified Preisach model that describes the mean position of a domain-wall under the action of an external field [10]. this model relates magnetization M to the applied H . Magnetic flux density B is calculated from magnetization by $B = \mu_0(H + M)$ and the intermediate parameters is the mean domain-wall position x . The model is history-

dependent and requires the last turning point of field H_0 and the mean domain-wall position x_0 . The following equations summarize model [11].

$$x(H) = \chi \cdot \text{sgn}(H) \cdot [(1-c) \cdot P_{irr}(|H|) + c \cdot |H|] \quad H_0 = 0 \quad (5a)$$

$$x(H) = x_0 + 2\chi \cdot \text{sgn}(H - H_0) \cdot \left[(1-c) \cdot P_{irr}\left(\left|\frac{H - H_0}{2}\right|\right) + c \cdot \left|\frac{H - H_0}{2}\right| \right] \quad H_0 \neq 0 \quad (5b)$$

$$P_{irr}(\Delta H) = \Delta H - H_c / (1-c) + H_c / (1-c) \cdot \exp\left(\frac{-\Delta H}{H_c / (1-c)}\right) \quad (6)$$

$$dm = R(m) \cdot dx \quad (7)$$

The model parameters include maximum susceptibility χ , a dimensionless coefficient associated with reversible magnetization, $0 < c < 1$ and the coercive force H_c . The function P_{irr} is associated with the irreversible process of magnetization and the function $R(m)$ that is called domain-wall surface function, forms the shape of the hysteresis loop in saturation state and m is normalized magnetization. One choice of $R(m)$ is given in [10]:

$$R(m) = 1 - m^{2r} \quad \rightarrow \quad x = \int \frac{dm}{1 - m^{2r}} \quad (8)$$

All parameters of static model should be extracted from measured data and a curve fitting method.

3. Solving the network

3.1. Computation method

After forming the reluctance network as fig. 2 and determination of elements parameters, well-known node analysis method can be used to compute the scalar magnetic voltage e_{mi} of each node. To solve the network, we need to calculate mmf of the tape elements. Therefore, the winding current of transformer is required. If the transformer is used in an electrical circuit and the winding current is unknown, we have to solve the magnetic network and

electrical circuit simultaneously using iterative methods. In linear modeling of the core, the permeability of R_{li} is constant and predefined. Therefore, a simple iterative method for solving linear systems such as Gauss–Seidel method can be used to solve the electrical and magnetic circuit. For nonlinear modeling in addition of the windings current, relative permeability of the nonlinear reluctances is unknown and is a function of flux density. Therefore, an iterative method with better and faster convergence needs to determine the current of coil and the permeability of reluctances simultaneously. Here a function F is defined in (9) and Newton’s method is used to find the roots of this function and solving the nonlinear system.

$$F = \left[\mu_{r1}^0 - \mu_{r1}, \dots, \mu_{rN}^0 - \mu_{rN}, I^0 - I \right] \quad (9)$$

Where μ_{ri}^0 is the initial value of the relative permeability of element i and μ_{ri} is the obtained value from the reluctance network analysis and is used for modifying the initial value. Also I^0 and I are the initial value of the current and the calculated one from the electrical circuit respectively. For transient simulation, the mentioned method is used in each step and the initial values are defined from previous step calculations. The applied algorithm for transient simulation is depicted in fig. 3. At the start of each step, the initial values of current and permeability of the elements are selected. After forming the network and calculating Jacobian of F , the new value of longitudinal and transverse fluxes are determined. Then the winding current and permeabilities are computed. If the error is more than the desired value this process is repeated by computed values, else a new time step is started.

After solving the network, magnetic voltages of nodes are obtained and longitudinal and transverse fluxes passing through the elements can be computed. Induced voltage in the windings is determined by derivative of the total flux within the core and the magnetic loss is calculated from the flux density of elements.

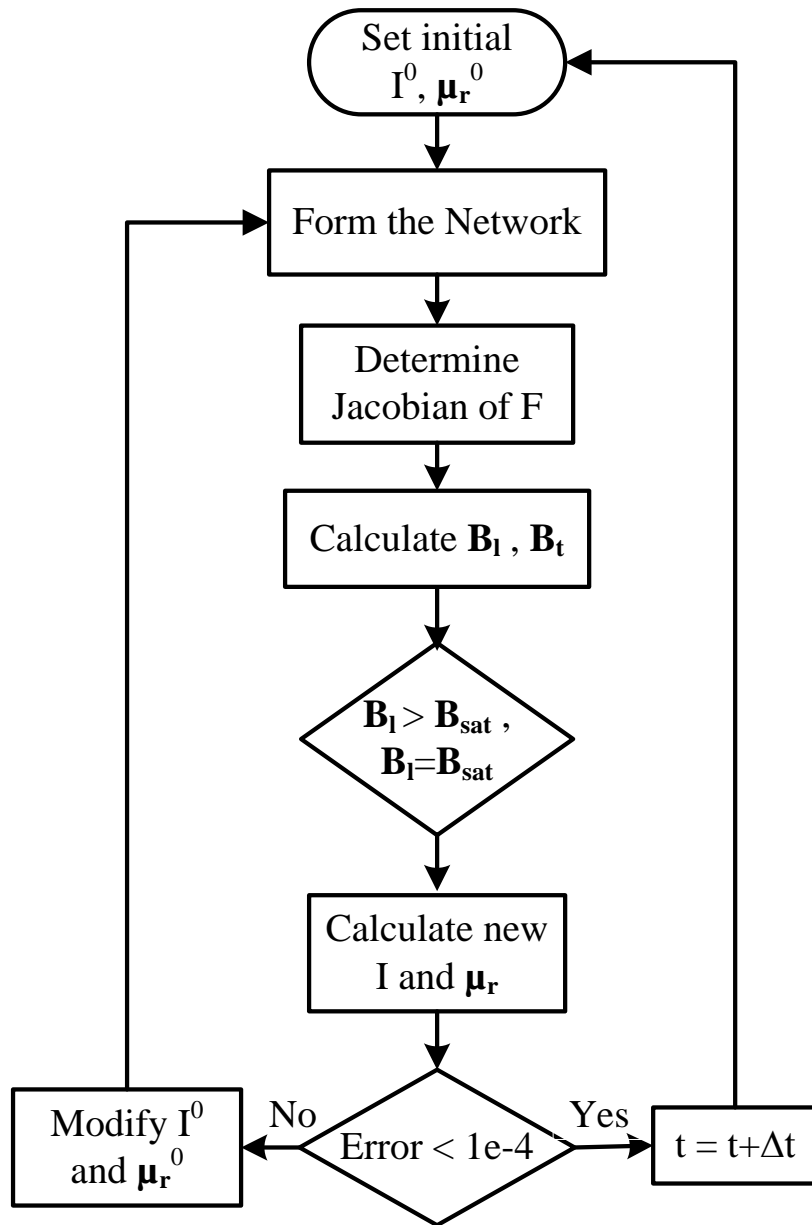

Figure 3. Applied algorithm for time dependent simulation of RNM (subscript l and t refer to longitudinal and transverse respectively.)

3.2. Number of elements

In the presented method, number of elements and the length of them specify the accuracy of the results and the simulation time consequently. Assuming an equal number of elements in each turns of tape, to have a good criterion about the number of elements in turns, a test method is applied on the model and an error value is obtained to decide about the accuracy of

modeling. In this test method after partitioning the core, a defined current is applied on the coil and the system is solved in linear mode. Then a close path in the core is selected and by knowing the magnetic field H of each element (obtained from model) and using the Ampere's law, ampere-turn that is surrounded by the selected path is calculated and coil current is determined. Error between this computed current and the initial applied current could determine the accuracy of the model.

4. Simulation and results

To demonstrate the performance of this method two simulations are performed for linear and nonlinear mode. The core of transformer is made of Nanocrystalline ferromagnetic tape with the characteristic of Table 1. FEM simulations are used to validate the calculations in linear mode and measurements validate the results of nonlinear modeling.

4.1. Linear modeling

To illustrate distribution of the fluxes within the core, a core with 25 turns of the magnetic tape is used. FEM simulations are performed in Maxwell software [12] and are compared with results of the presented model. Inner diameter of the core is 10 (mm). A small size core is selected because automatic meshing of Maxwell software is so time consuming. In RNM each turns of tape is divided to 300 elements to have an error below 2% in base of the presented test method. A constant $\mu_r = 30000$ for each element is assumed and applied ampere-turn of transformer is 0.2 (A).

Table 1. The properties of Nanocrystalline tape used transformer core

Thickness	18 μm
Height	10 mm

Thickness of insulator	4 μm
Conductivity	833000 S/m
Saturation flux density	1.23 T
Density	7.3 g/cm ³

Figure 4 shows the longitudinal flux density of the core on a line passing through the middle of the tape. It is illustrated that the longitudinal flux has large variation at the first and last turns of tape. At the middle turns, the flux has a small decrease due to increase of flux path length. Figure 5 shows the transverse flux density of the core at a line passing through the middle of the gap. At the first and last turns of tape, large part of the flux close their path from the gap, therefore the transverse flux has a bigger value. However, at middle turns, the transverse flux has a small value and indicates the distributed natural gaps in the structure of the core.

Normalized root mean square error (NRMSE) is used as a numerical scale for comparison of FEM and RNM results, as follows:

$$NRMSE = \frac{1}{y_{\max} - y_{\min}} \sqrt{\frac{1}{n} \sum_{i=1}^n (y_i - \hat{y}_i)^2} \quad (10)$$

Where y is the actual value obtained from FEM, \hat{y} is the calculated value and n is number of samples. For longitudinal flux (fig. 4), the computed NRMSE is 2.2% that shows the good accuracy of the presented model. NRMSE for transverse flux is about 3.6%. Error in calculation of transverse flux is bigger because not all of the fluxes transversely enter the gaps.

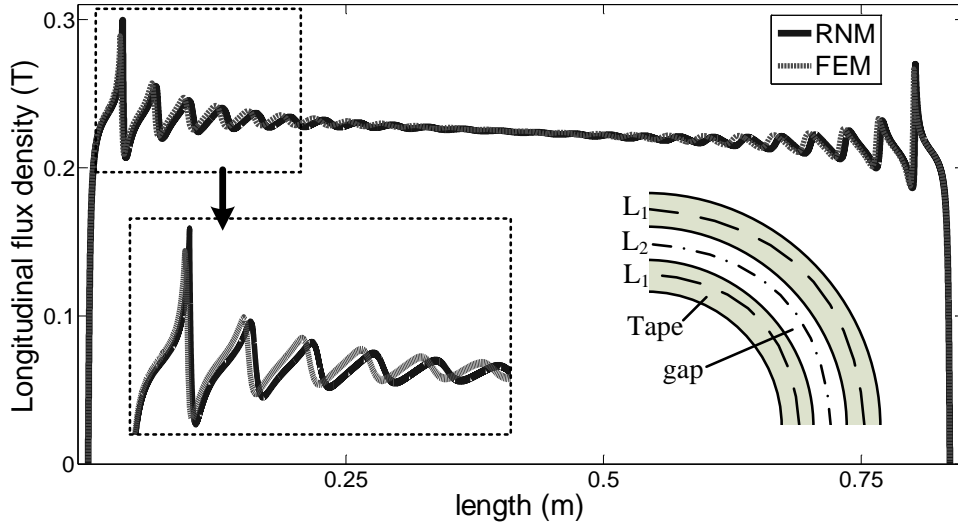

Figure 4. Distribution of longitudinal flux density along middle of the tape (line L1) in a wound core

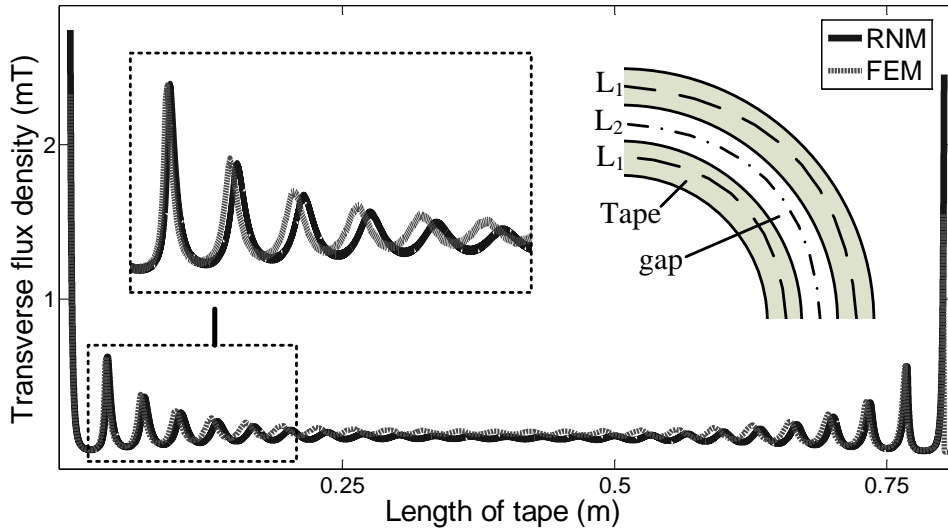

Figure 5. Distribution of transverse flux density along middle of the gap (line L2)

4.2. Nonlinear modeling

For nonlinear modeling, a series- resonant convertor for capacitor charging power supply is used (fig. 6). This topology has a resonance circuit and a step up transformer. The transformer consists of three wound tape cores that each one made of 220 turns of the tape with 32 (*mm*) inner diameter, 43.6 (*mm*) outer diameter and 10 (*mm*) height. There are 30 turns of litz wire in primary winding and a square pulse of 300 V, 20 *kHz* is applied to it.

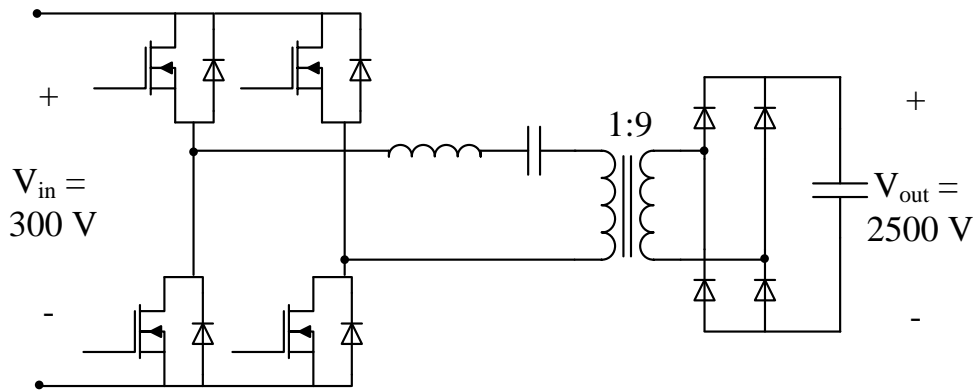

Figure 6. Series-resonant convertor topology used in capacitor charging power supply

To achieve a modeling error below 5%, each turn of tape in cores is divided to 450 elements. Simulation is performed for time steps of 100 ns. Maxwell software can model the magnetic characteristic of material but not the hysteresis loop so the calculated results are compared with measurements. The hysteresis model parameters that are obtained from measurement are listed in Table 2. On average, each step takes about 13 seconds for a PC with CORE™ i7 CPU and 16 GB of RAM. The skin effect could be neglected in simulation because the skin depth of tape for this frequency ($\delta \approx 27 \mu\text{m}$) is larger than the thickness of tape.

Table 2. Parameters of hysteresis model obtained by curve fitting

Static model Parameters					Dynamic model parameters	
c	χ	H_c	B_s	r	α	$g(B)$
0.67	0.87	2.8	1.18	1	1.91	$0.02 \times (1 + 0.74 \times B^2)$

Leakage inductance and stray capacitance of transformer are separately calculated and applied on electrical circuit [13]. Figure 7 shows the induced voltage in primary winding.

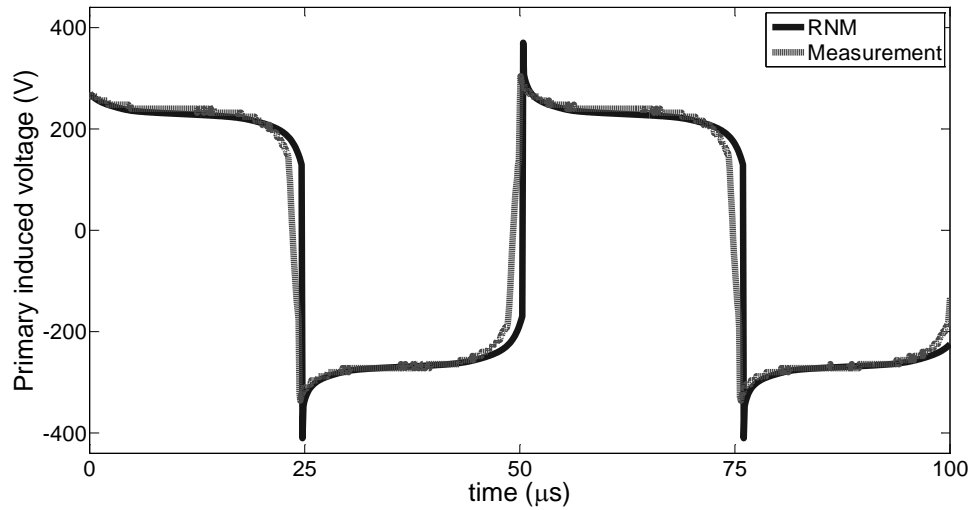

Figure 7. Induced voltage in primary winding

Figures 8 and 9 show H and B for the transformer. The reasons for the difference between measured and simulated values of H are the errors of parasitic elements calculation, the error of finding the parameters of hysteresis model, and also weak convergence of the iterative method near the points with high value of H .

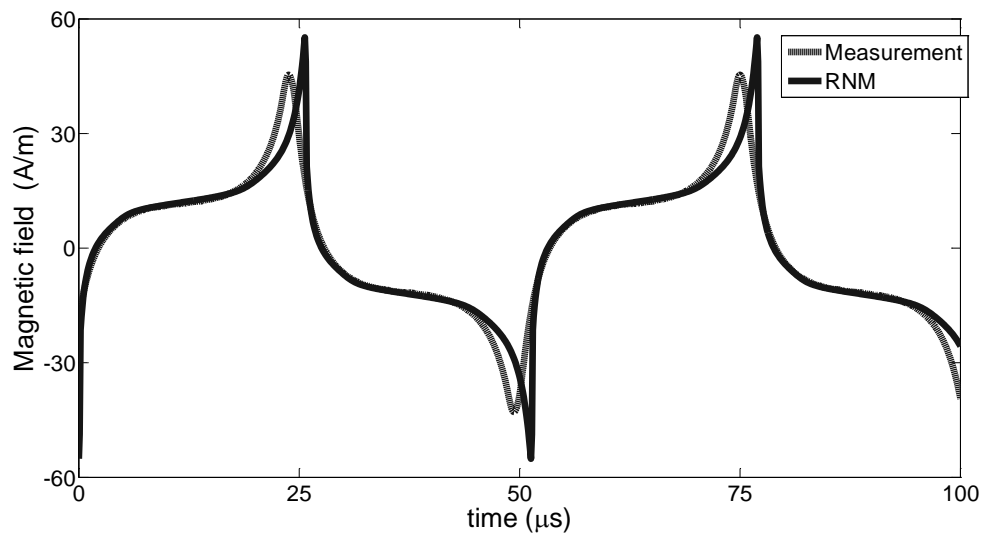

Figure 8. Measured and calculated magnetic field of transformer

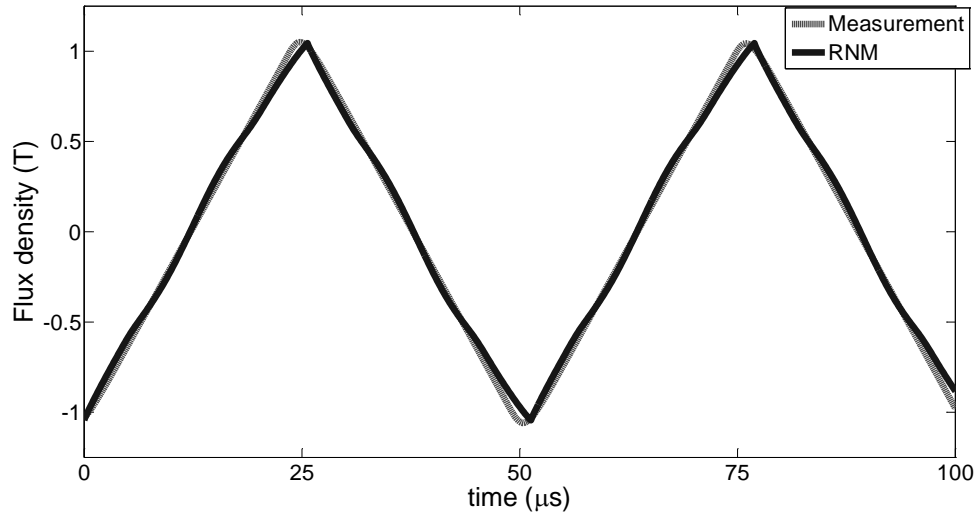

Figure 9. Measured and calculated flux density of transformer

Figure 10 shows the measured hysteresis loop and the calculated using dynamic model also static loop of core. Calculated magnetic loss of transformer is about 136.4 W/kg in accordance with the manufacturer's information that specifies 141.5 W/kg for maximum flux density of 1 T and frequency of 20 kHz [14]. Hysteresis loss is about 28% of total magnetic loss, classical loss is 25% and the remaining is excess loss.

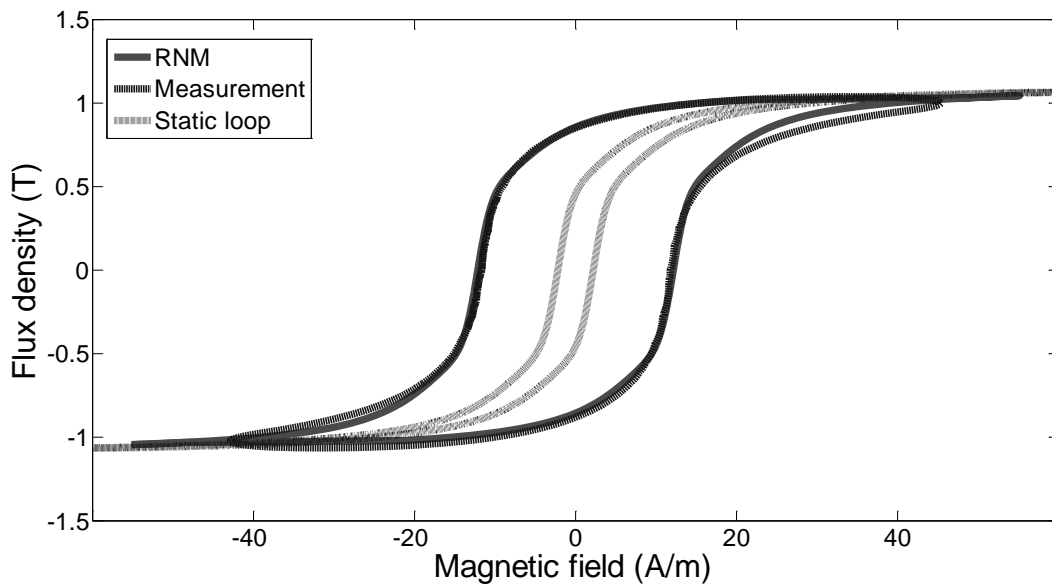

Figure 10. Measured and calculated dynamic hysteresis loop of transformer and static loop

5. Conclusion

In this paper, RNM is used to model tape wound cores. The presented model can determine the distribution of flux within the core so that the effect of distributed gaps of the core and large variations of the flux at beginning and end of the core are observable in the results. Having flux distribution, induced voltage and magnetic losses can be easily calculated. As a scale of modeling error, a simple test method is presented that could be used to have a desired level of error with minimum time of simulation. The FEM results show the acceptable precision of the model. Adding a dynamic hysteresis model, improves the performance of model and the measurements validate it. Simple implementation and fast convergence are advantages of this method. To eliminate error of the results due to large variations of elements permeability, advanced methods of solving nonlinear systems can be applied or an approach independent of permeability should be used. Although the model only takes into account the fluxes within the core and the leakage fluxes are neglected. However, leakage inductance can be determined separately by using conventional methods and then added to electrical circuit. Low thickness of the magnetic tapes allows using this model for a wide range of frequency.

References

- [1]. S. Zurek, F. Al-Naemi, and A. J. Moses, "Finite-Element Modeling and Measurements of Flux and Eddy Current Distribution in Toroidal Cores Wound From Electrical Steel", *IEEE Transactions on Magnetics*, vol. 44, no. 6, pp. 902-905, 2008.
- [2]. T. Nakata, N. Takahashi, K. Fujiwara, and M. Nakano, "Analysis of flux and eddy current distributions in wound cores and experiments", *Transactions on Engineering Sciences*, vol. 11, pp. 255-264, 1996.

- [3]. G. Loizosa, T. Kefalasb, A. Kladasb, T. Souflaris, and D. Pappas, “Flux distribution in single phase, Si-Fe, wound transformer cores,” *Journal of Magnetism and Magnetic Materials*, vol. 320, no. 20, pp. 874-877, 2008.
- [4]. I. Hernandez, F. de Leon, J. M. Canedo, and J. C. Olivares-Galvan, “Modeling transformer core joints using Gaussian models for the magnetic flux density and permeability”, *IET Electr. Power Appl.*, vol. 4, no. 9, pp. 761–771, 2010.
- [5]. C. R. Lines, W. A. Cronje, and B. Wigdorowitz, “Extended 2D magnetic equivalent circuit method”, *COMPEL*, vol. 29, no. 6, pp. 1435-1443, 2010.
- [6]. A. Ibala, A. Masmoudi, G. Atkinson, and A. G. Jack, “On the modeling of a TFPM by reluctance network including the saturation effect with emphasis on the leakage fluxes”, *COMPEL*, vol. 30, no. 1, pp. 151-171, 2011.
- [7]. J. Turowski, “Reluctance Networks”, in Sykulski, J. K., *Computational Magnetism*, Springer, Netherlands, pp. 145-164, 1995.
- [8]. S. E. Zirka, Y. I. Moroz, P. Marketos, and A. J. Moses, “A Viscous-Type Dynamic Hysteresis Model as a Tool for Loss Separation in Conducting Ferromagnetic Laminations,” *IEEE Transactions on Magnetics*, vol. 41, no. 3, pp. 1109-1111, 2005.
- [9]. S. E. Zirka, Y. I. Moroz, P. Marketos, A. J. Moses, and D. C. Jiles, “Viscous Behavior of Ferromagnets in the Voltage and Current Driven Regimes,” *IEEE Transactions on Magnetics*, vol. 44, no. 11, pp. 3189-3192, 2008.
- [10]. V. Basso, “Hysteresis models for magnetization by domain wall motion”, *IEEE Trans. Magn.*, vol. 34, pp. 2207–2212, 1998.
- [11]. P. Nakmahachalasint, K. D. T. Ngo, and L. Vu-Quoc, “A Static Hysteresis Model for Power Ferrites”, *IEEE Transactions on Power Electronics*, vol. 17, no. 4, pp. 453-460, 2002.
- [12]. “Getting Started with Maxwell: Designing a Rotational Actuator,” ANSYS Inc., 2010.

[13]. A. Baktash, and A. Vahedi, "Calculation of parasitic elements in Toroidal core transformers," IEEE Transaction on Plasma Science, Accepted.

[14]. "Nano-crystalline: A Special Product Announcement", MK Magnetics, 2007, available at: <http://www.mkmagnetics.com/dataSheets/pdf/mkm-nanoCurves.pdf>.