

Evaluation of Reliability Parameters in Micro-Grid

H. Hassanzadeh Fard*, S. A. Bahreyni*, R. Dashti*(C.A.) and H. A. Shayanfar*

Abstract: Evaluation of the reliability parameters in micro-grids based on renewable energy sources is one of the main problems that are investigated in this paper. Renewable energy sources such as solar and wind energy, battery as an energy storage system and fuel cell as a backup system are used to provide power to the electrical loads of the micro-grid. Loads in the micro-grid consist of interruptible and uninterruptible loads. In addition to the reliability parameters, Forced Outage Rate of each component and also uncertainty of wind power, PV power and demand are considered for micro-grid. In this paper, the problem is formulated as a nonlinear integer minimization problem which minimizes the sum of the total capital, operational, maintenance and replacement cost of DERs. This paper proposes PSO for solving this minimization problem.

Keywords: Forced Outage Rate, Micro-grid, Particle Swarm Optimization, Reliability.

1 Introduction

Relatively low efficiency of thermal power plants and 10%–15% of energy losses in transmission and distribution system makes centralized power generation a large consumer of fossil fuels. Using renewable energies, creating an appropriate consumption pattern, electricity restructuring and utilizing distributed generations are all valuable and useful ways to obviate this problem [1, 2]. However, problems such as limited space and development of networks, forming areas of high density, low power quality and voltage instability, large distance between the centers of production and consumption, the subsequent loss of transmission lines, the risk caused by the shortage of fossil energy resources, and environmental issue, etc. led to the change strategies of power generation development [3]. Obtaining the maximum potential of distributed energy resources, a new architecture called micro-grid system has been developed in recent years. Micro-grid power systems are a type of energy system which uses local power to meet the local loads and can be isolated from or connected to the main grid. The main difference between conventional distributed generation units and micro-grid system is that distributed generations are small power producers which are being near the energy users, while in the micro-grids power producers and loads are controlled and managed to obtain a

simultaneous balance of power and local energy [4]. The main purpose of the electric power system is to provide reliable and affordable energy for consumers [5].

Various optimization techniques of hybrid systems sizing have been done [6-11]. Reference [12] presents a model for calculating the optimal size of an ESS in a micro-grid considering reliability criterion. In [13] optimal sizes for wind turbine, PV arrays and the diesel generator in an islanded micro-grid have been investigated. In [14] a novel intelligent method is applied to the problem of sizing in a hybrid power system such that the demand of residential area is met. References [15-21] use optimization method to determine the optimal size of each unit in the hybrid system consists of renewable energy. Reference [22] determines the optimal site and size of DGs in distribution system considering the uncertainties in output power of wind turbines and PV arrays. Reference [23] presents a procedure to evaluate different PV schemes considering the stochastic natures of the insulation and the load. The reliability measures in terms of Loss Of Load Hours (LOLH), the energy loss and the total cost have been used as the indices for evaluation of different schemes. Reference [24] sets up a formulation to determine the optimal contract capacities and optimal size of battery energy storage systems for time-of-use rate customers. Reference [25] proposes a heuristic technique for allocation of distribution generation source in a distribution system. The allocation is determined based on overall improvement in network performance parameters like reduction in system losses, improvement in voltage

Iranian Journal of Electrical & Electronic Engineering, 2015.

Paper first received 12 Feb. 2014 and in revised form 18 Jan 2015.

* The Authors are with the Center of Excellence for Power Systems Automation and Operation, Department of Electrical Engineering, Iran University of Science and Technology (IUST), Tehran, Iran.

E-mails: h_hassanzadehfard@iust.ac.ir, bahreyni@iust.ac.ir, rezadashti83@yahoo.com and hashayanfar@yahoo.com.

stability, improvement in voltage profile. The optimization methodology proposed in [26] uses the ANFIS (Adaptive Neuro-Fuzzy Inference System) to model the PV and wind sources. The optimized system is also able to supply power to the load without any renewable sources for a longer period, while conforming to the desired LPSP. In [27-28] optimization of a wind-PV integrated hybrid system is presented. Based on Deficiency of Power Supply Probability, Relative Excess Power Generated, Unutilized Energy Probability, Life Cycle Cost, Levelized Energy Cost and Life Cycle Unit cost of power generation with battery bank, the method addresses a specific location and employs an iterative scheme. Optimum sizing of integrated system involving diesel generator and battery bank for an isolated electrical power generation is proposed in [29]. Reference [30] presents a new methodology using Fuzzy and ABC algorithm for the placement of DG units in the radial distribution systems to reduce the real power losses and to improve the voltage profile. A stochastic model for operational planning of smart power system is presented in [31]. Reference [32] attempts to evaluate distribution system efficiency putting together different standpoints. In [33] distribution marginal cost is obtained based on the external factors such as governance, social behavior and urban planning. These factors effect on consumers' quality and reliability.

The aforementioned papers do not consider the following factors in their studies: Forced Outage Rate for wind turbines, PV arrays and converters, uncertainty in output power of wind turbines, PV arrays and demand of the micro-grid and also reliability parameters, interruptible and uninterruptible loads in the micro-grid.

In this paper optimization of the micro-grid based on wind, solar, fuel cell and battery storage has been done. Reasons for using these units include: solar and wind units due to environmental conditions and use of clean energy, fuel cells as reliable backup and batteries as energy storages. Loads in the micro-grid consist of interruptible and uninterruptible loads. FOR of each component, some reliability parameters and also uncertainty of wind power, PV power and demand are considered for micro-grid. The optimization is carried out via PSO algorithm. Section.3 expresses description of the micro-grid components such as wind turbine, PV arrays, fuel cell, battery storage, and system modeling, section.4 describes the strategy of producing required load in micro grid, section 5 explain micro-grid's cost, the objective function is introduced in section. 6, section.7 is about some reliability parameters, section.8 presents forced outage rate, section.9 describes calculations of uncertainty. Section.10 presents some simulation results. Finally conclusion of this study is described.

2 Description of the Micro-Grid Components

2.1 Wind Turbine

There are some relationships to calculate the output power of wind turbine. The outlet energy of a turbine could be calculated from its power-speed curve [34]. Reference [34] describes the power of the wind turbine in terms of the wind speed:

$$\begin{cases} 0 & ; V < V_{cut-in}, V > V_{cut-off} \\ P_{rated} \left(\frac{V - V_{cut-in}}{V_{rated} - V_{cut-in}} \right)^3 & ; V_{cut-in} \leq V < V_{rated} \\ P_{rated} & ; V_{rated} \leq V \leq V_{cut-off} \end{cases} \quad (1)$$

in which V_{cut-in} , $V_{cut-off}$, V , V_{rated} and P_{rated} are cut-in wind speed (m/s), cut-out wind speed (m/s), wind speed (m/s), nominal wind speed (m/s) and the rated power of wind turbine (kW), respectively. In this analysis, each wind turbine has a rated capacity of 50 kW. Cost of one unit is considered 60000 \$ while replacement and maintenance costs are taken as 50000 \$ and \$900/year. Lifetime of a wind turbine is taken to be 20 years.

2.2 PV Array

The use of solar energy has been growing. Power generation of solar systems depends on the solar radiation. Solar arrays have simple technology, converts directly radiation energy into electrical energy and has low noise. The output power of the PV generator P_{pv} can be calculated according to the following equation [35]:

$$P_{pv} = N * P_{mpv} * G_t / 1000 \quad (2)$$

where P_{pv} is the output power of PV arrays (W), P_{mpv} is the rated power of each array under the condition $G_t = 1000$, G_t is the global irradiance incident on the titled plane (W/m^2) and N is the number of modules. In this analysis, each PV array has a rated power of 1 kW. The capital cost is considered 4000 \$ for one unit, while replacement and maintenance cost are taken as 3000 \$ and 0 \$/year respectively. Lifetime of a PV array is taken to be 20 years.

2.3 Fuel Cell

A fuel cell is an electrochemical process in which chemical energy stored in fuel, is directly converted to DC power, without the need for turbines and generators and without combustion or pollution. Fuel cell is one of the new technology, which has good adaptability to the environment and the energy transformation takes place with high efficiency. In this paper the Proton Exchange Membrane (PEM) fuel cell, which is well suited for hybrid systems and micro-grid and has suitable function temperature (80-100° C) [36], [37], is used. PEM fuel cell is an environmentally clean power generator which combines hydrogen fuel with oxygen from air to produce electricity. The capital cost, replacement costs and operational cost are taken as 3500 \$, 3000 \$ and

175 \$/year for a 1 kw system, respectively. Fuel cell's lifetime is considered to be 5 years.

2.4 Battery Storage

Given that output power of PV arrays and wind turbines significantly depends on the weather conditions, natural variations in wind speed and solar radiation that can cause fluctuations in output power of wind and solar units. Therefore, to use the maximum capacity of wind turbines and PV arrays, the battery is used as energy storage device [38]. Battery storages are used for storing electricity by charging battery at time when the electricity power generation is excess and discharge in the day peak time or in the shortage of energy supply. At any hour the state of battery is related to the previous state of charge and to the energy production and consumption situation of the system during the time from t-1 to t. In all cases the storage battery capacity is subject to the following constraints:

$$E_{bat\ min} \leq E_{bat}(t) \leq E_{bat\ max} \quad (3)$$

where $E_{bat\ max}$ and $E_{bat\ min}$ are the maximum and minimum allowable storage capacities. $E_{bat\ min}$ is determined by the maximum allowable depth of battery discharge (DOD) as follows:

$$E_{bat\ min} = (1 - DOD) * E_{bat\ max} \quad (4)$$

2.5 Load Model

The loads consist of interruptible and uninterruptible. Interruptible loads are consumers who agree to be interrupted, or whose consumption may be reduced by the utility, in order to maintain system security or to reduce micro-grid prices. The cost of electricity interruptions has been estimated. The cost that we use in our model for interruptible loads is 0.56 \$/kWh and for uninterruptible loads is 5.6 \$/kWh [39]. We assume that in each hour 10 % of loads are interruptible and 90 % of loads are uninterruptible and at any each hour micro-grid can interrupt only 10% of uninterruptible loads subject to reliability constraint.

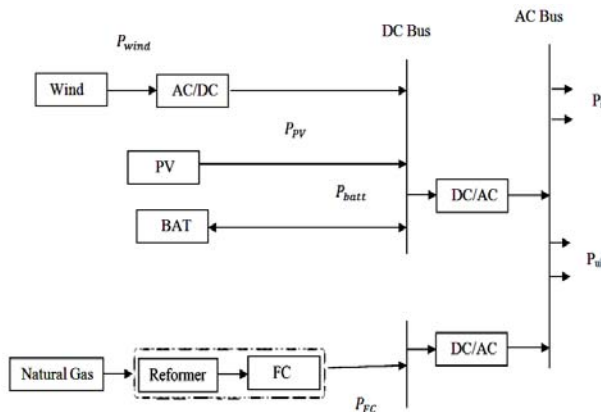

Fig. 1 Schematic diagram of micro-grid.

3 Proposed Model

Micro-grid studied in this paper is shown in Fig. 1. We consider three situations for micro-grid: 1. power generated by renewable energy (wind + PV) meets demand, 2. over generation and 3. over demand.

A. Power generated by wind and PV meets demand

In this situation the power generated by the wind turbine plus the power produced by the PV array is equal to the demand, hence:

$$P_{wind}(t) + P_{PV}(t) = (P_{Load}(t) / \eta_{DC/AC}) \quad (5)$$

where $P_{wind}(t)$, $P_{PV}(t)$ and $P_{Load}(t)$ are output power of wind turbines, PV arrays and demand of the micro-grid respectively. $\eta_{DC/AC}$ is the DC/AC efficiency. $E_{bat}(t)$ and $E_{bat}(t + \Delta t)$ are stored energy in battery banks at the time t and t+1. It is notable that the time steps Δt are taken to be 1 hour in this study.

B. Over generation

The produced power of the wind turbine plus power produced by the PV array are more than the demand.

The excess power is utilized for charging the batteries. Equations are as follows:

$$P_{wind}(t) \times \eta_{AC/DC} + P_{PV}(t) > (P_{Load}(t) / \eta_{DC/AC})$$

$$E_{bat}(t + \Delta t) = E_{bat}(t) + [(P_{wind}(t) \times \eta_{AC/DC} + P_{PV}(t) - (P_{Load}(t) / \eta_{DC/AC})) * \Delta t * \eta_{cha}] \quad (6)$$

$$P_{FC}(t) = 0$$

where η_{cha} is the battery charger efficiency. If the surplus produced power of PV arrays plus wind turbines after charging batteries is overflowed, stored energy in the battery banks according to Eq. (7) will be equal to its maximum capacity:

$$E_{bat}(t) = E_{bat\ max} \quad (7)$$

C. Over demand

The demand is more than the power generated by the wind turbines and power produced by the PV array:

$$P_{wind}(t) \times \eta_{AC/DC} + P_{PV}(t) < (P_{Load}(t) / \eta_{DC/AC}) \quad (8)$$

In this situation we have two cases:

a. Available energy of battery banks and power generation of wind turbine plus PV array can meet demand.

$$P_{wind}(t) \times \eta_{AC/DC} + P_{PV}(t) + (E_{bat}(t) - E_{bat\ min}) * \eta_{dech} / \Delta t > (P_{Load}(t) / \eta_{DC/AC}) \quad (9)$$

Therefore:

$$E_{bat}(t + \Delta t) = E_{bat}(t) + (P_{wind}(t) \times \eta_{AC/DC} + P_{PV}(t) - (P_{Load}(t) / \eta_{DC/AC})) * \Delta t / \eta_{dech} \quad (10)$$

$$P_{FC}(t) = 0$$

where η_{dech} is the battery discharging efficiency.

b. Available energy of battery banks and power generation of wind turbine plus PV array cannot meet demand:

In this situation the battery banks are completely discharged and the energy in the battery banks is equal to $E_{bat\ min}$. Therefore, load requirements are supplied from the fuel cell P_{FC} :

$$E_{bat}(t + \Delta t) = E_{bat\ min} + P_{FC}(t) - (P_{Load}(t) / \eta_{DC/AC}) - P_{PV}(t) - P_{wind}(t) \times \eta_{AC/DC} - (E_{bat}(t) - E_{bat\ min}) * \eta_{dech} / \Delta t \quad (11)$$

In this state if the total produced power cannot satisfy demand, first interruptible and then uninterruptible loads are interrupted due to reliability parameters.

First PSO finds the optimal size of each component. Then uncertainty, Forced Outage Rate and reliability are considered respectively according to Fig. 2.

3.1 Micro-Grid Cost

Economic comparison of projects is the most important decision for managing purposes. The most economic project should be considered according to techniques and applications of engineering economy. Present value method is the simplest and one of the most important techniques of engineering economics. Calculation of the present value of a financial process is the conversion value of all future costs to the present value of the project is being. We choose NPC for calculation of the system. NPC of each component is defined as [40]:

$$NPC = N * (capital_cost + replacement_cost * K + operation \& maintenance_cost * \frac{1}{CRF(ir, R)}) \quad (12)$$

$$CRF(ir, R) = \frac{ir * (1 + ir)^R}{(1 + ir)^R - 1}, K = \sum_{n=1}^y \frac{1}{(1 + ir)^{L * n}}$$

L is the lifetime and N is the optimal number of each component, ir is interest rate and R is the lifetime of project.

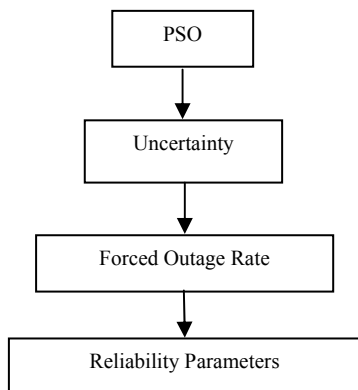

Fig. 2 Considering the indicators.

3.2 The Objective Function

The objective function is the sum of all net present costs:

$$NPC = NPC_{wind} + NPC_{PV} + NPC_{battery} + NPC_{FC-ref} + NPC_{DC/AC} + NPC_{AC/DC} + NPC_{Pi} + NPC_{Pui} \quad (13)$$

where NPC_{Pi} and NPC_{Pui} are net present cost for interruptible and uninterruptible loads respectively.

The objective function must be minimized, which is done by PSO algorithm in this paper.

3.3 Calculations of Uncertainty

With the advances in wind turbine technology, wind energy can compete with other fuel-based energy sources. But uncertain nature of wind speed is a problem in the use of wind power production. This problem makes it difficult to choose the optimal size of wind turbines. To ensure system reliability, considering the uncertainty of wind speed in the production of wind power capacity is essential. Several methods have been used to model the uncertainty of wind speed [41]. In the presented method, the deviations for wind power, PV power and loads are simulated similar to an actual change wave by the following functions as presented in [41]:

$$dP_{PV} = 0.7 * \sqrt{P_{PV}}, dP_{wind} = 0.8 * \sqrt{P_{wind}}, dP_{Load} = 0.6 * \sqrt{P_{load}} \quad (14)$$

Therefore, in this paper, the uncertainty of wind power, PV power and demand are obtained using multiplication of the random output fluctuation derived from the white noise block in MATLAB/SIMULINK by fluctuations on generation and loads. So the output power of wind turbines, PV arrays and demand considering uncertainty are obtained by following equations:

$$P_{PV_un} = dP_{PV} * noise + P_{PV}$$

$$P_{wind_un} = dP_{wind} * noise + P_{wind} \quad (15)$$

$$P_{Load_un} = dP_{Load} * noise + P_{Load}$$

3.4 Forced Outage Rate

The basic generating unit parameter used in static capacity evaluation is the probability of finding the unit on forced outage at some distant time in the future. This probability was defined in Engineering Systems as the unit unavailability, and historically in power system applications it is known as the unit FOR. Forced outage rates of generating units are known to be a function of size and type of unit and therefore a fixed percentage reserve cannot ensure a consistent risk. In this section we consider forced outage rate for some components in the micro-grid. The amount of FOR for PV arrays (FOR_{PV}), wind turbines (FOR_{wind}) and converters (FOR_{conv}) are equal to 4%, 4% and 0.11% respectively [39].

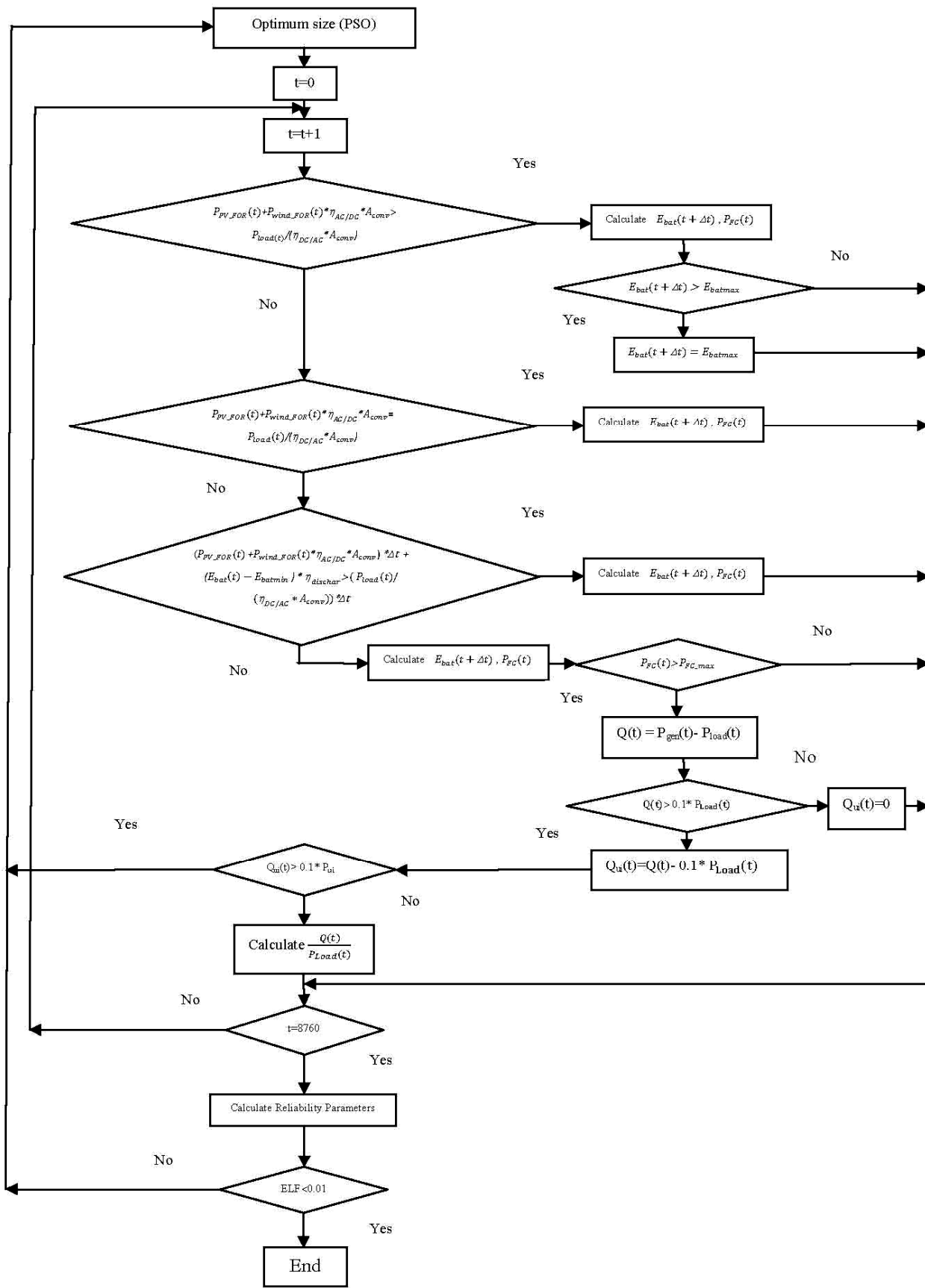

Fig. 3 Proposed algorithm.

So output power of wind turbines and PV arrays considering FOR can be calculated according to the following equations [39]:

$$P_{wind_FOR} = P_{wind} \times A_{wind} \quad (16)$$

$$P_{PV_FOR} = P_{PV} \times A_{PV} \quad (17)$$

where A_{wind} and A_{PV} are availability of wind turbines and PV arrays. For considering forced outage rate for converters, efficiency of converters is multiplied by availability of converters A_{conv} obtained by following equation:

$$A_{conv} = (1 - FOR_{conv}) \quad (18)$$

3.5 Reliability

Several indices have been proposed for estimating the reliability of systems [14, 42]. Some reliability parameters are commonly used for systems with hourly demand and supply data. LOLE, LOEE, LPSP and ELF are some of them that considered in this paper.

These parameters are defined by the following equations:

$$LOLE = \sum_{t=1}^N E[LOL(t)] \quad (19)$$

where $E[LOL(t)]$ is expected load not supplied at the time t , which is defined by Eq. (20):

$$E[LOL] = \sum_{s \in S} T_s \times P_s \quad (20)$$

where P_s is probability of state s , T_s is the load outage time in this state, and S is the set of all possible states for the system.

$$LOEE = EENS = \sum_{t=1}^N E[LOE(t)] \quad (21)$$

where $E[LOE(t)]$ is the expected amount of load in the time interval t , defined by following equation:

$$E[LOE] = \sum_{s \in S} Q_s \times P_s \quad (22)$$

where Q_s is the loss of load in s condition. Loss of Power Supply Probability (LPSP) is shown in Eq. (23):

$$LPSP = \frac{LOEE}{\sum_{t=1}^N D(t)} \quad (23)$$

$D(t)$ introduces the load at the time t . ELF is described by:

$$ELF = \frac{1}{N} \sum_{t=1}^N \frac{Q_{ui}(t)}{P_{ui}(t)} \quad (24)$$

where $P_{ui}(t)$ is uninterruptible load, $Q_{ui}(t)$ is loss-of-uninterruptible load and N is the number of hours. The ELF contains information about both the number of

outages and their magnitude [14], [38]. In this paper we regard that ELF should be lower than 0.01.

$$ELF \leq 0.01 \quad (25)$$

Fig. 3 shows the proposed algorithm.

4 Numerical Study

In this paper, an IEEE standard curve with 500 kW peak is used. Lifetime of the project is 20 years and interest rate is considered 8%. The maximum allowable depth of battery discharge is considered 0.8. In this model 10% and 90% of loads are considered as interruptible and uninterruptible loads respectively. In this article, the optimum combination of the considered micro-grid is calculated. This system is optimized using PSO algorithm. Load curves, solar radiation and wind speed are shown in Figs. 4, 5 and 6.

We assume two situations in this study: considering the maximum number of fuel cell installed in micro-grid, without any fuel cell.

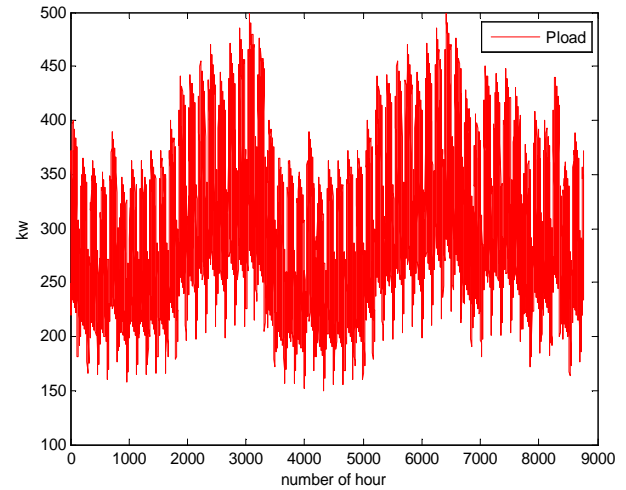

Fig. 4 Load information.

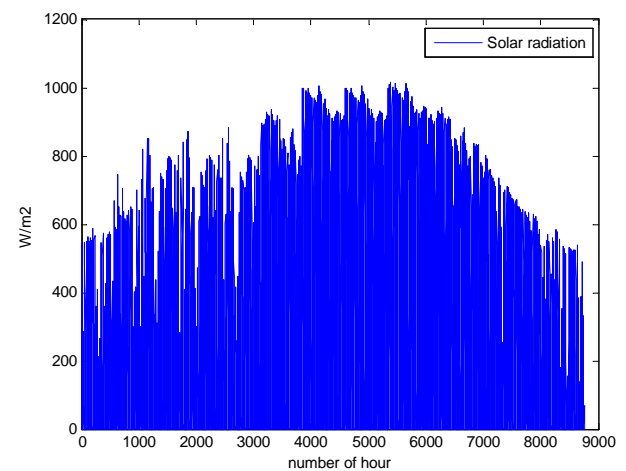

Fig. 5 Solar radiation curve.

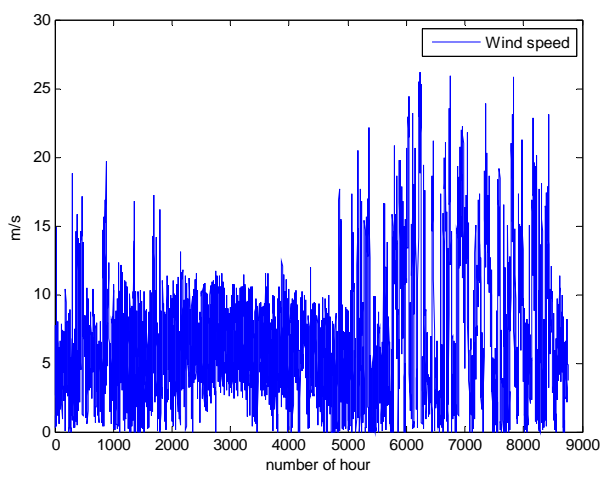

Fig. 6 Wind speed curve.

4.1 Maximum Installed Fuel Cell 350 kW

The optimal size of each component is shown in Table 1. Also, Table 2 shows the amounts of interruptible and uninterruptible which are not supported.

Considering penalty for interrupted loads, total cost of the micro-grid becomes equal to 1.6364×10^7 \$. Figs. 7-10 show the output power of fuel cell, energy of battery storages, interruptible and uninterruptible loads in each hour in which they are not supported.

Table 1 Optimal size of each component.

Fuel Cell	Wind Turbine	PV Array	Battery Bank	Micro-Grid Cost \$
349	19	1533	4798	16.339M

Table 2 Optimal size of exchanged power, interruptible and uninterruptible loads.

Uninterruptible Loads (kWh)	Interruptible Loads (kWh)
337.2166	1.339×10^3

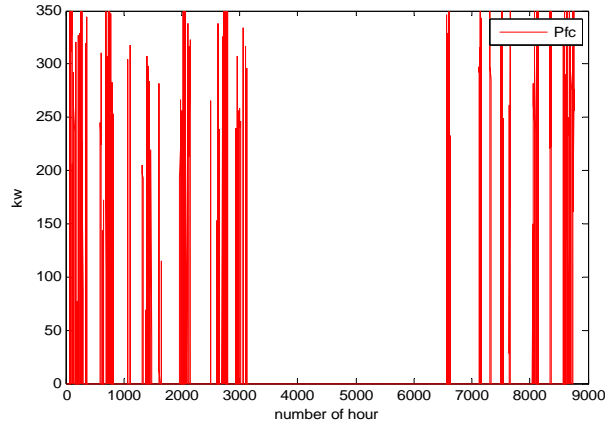

Fig. 7 Output power of fuel cell.

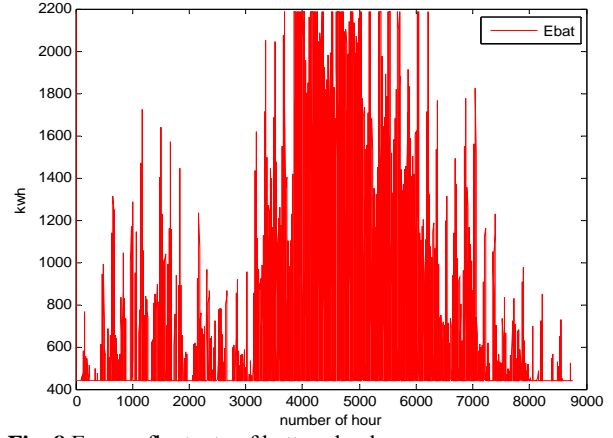

Fig. 8 Energy fluctuate of battery banks.

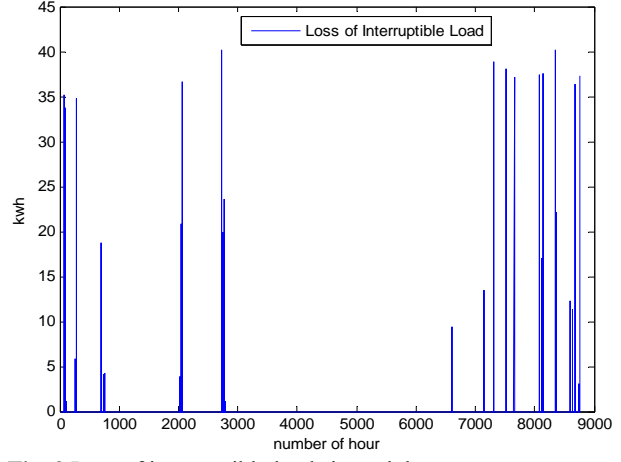

Fig. 9 Loss of interruptible loads in each hour.

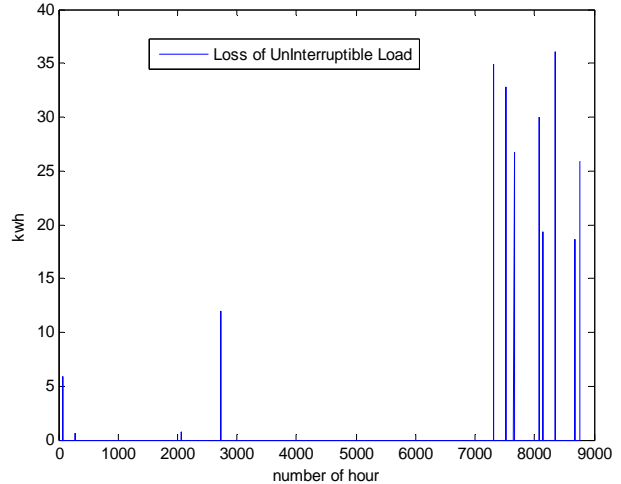

Fig. 10 Loss of uninterruptible loads in each hour.

When the power is between 3500-6500 output power of PV arrays and wind turbine with available battery storage energy can satisfy demand, so at these hours fuel cells do not produce any power.

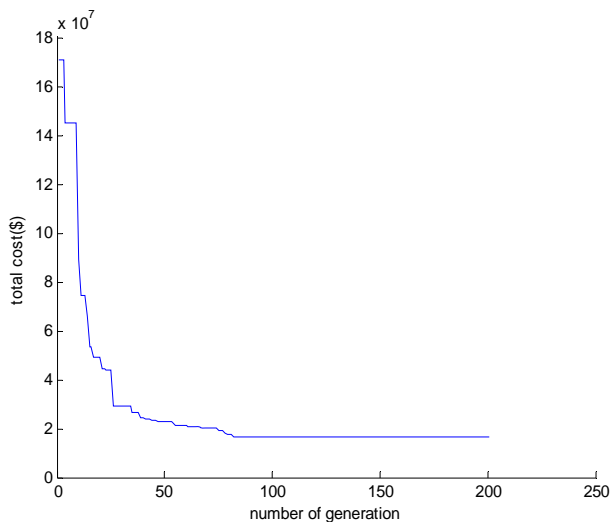

Fig. 11 The cost of micro-grid in terms of the iterations.

Also interruptible and uninterruptible loads are not shed. When available battery storage energy with output power of PV array and wind turbine cannot meet demand fuel cell will inject power to the micro-grid. When the total produced power in the micro-grid, cannot satisfy the demand, first the interruptible loads, and then the uninterruptible loads, are interrupted. The amount of some notions of reliability is shown in Table 3. This table shows that ELF is in the acceptable bound. Fig. 11 shows the system costs in terms of the iterations.

4.2 Without Fuel Cell

In this section, the fuel cell does not exist in the micro-grid. Table 4 shows total cost of micro-grid and optimal size of each component. Optimal size of interruptible and uninterruptible loads is shown in Table 5. The amount of some reliability parameters is shown in Table 6.

Table 3 Amount of some notions of reliability.

LOLE (hr/yr)	LPSP	LOEE (MWh/yr)	ELF
20	0.13771×10^{-3}	0.33721	0.10226×10^{-3}

Table 4 Optimal size of each component.

Wind Turbine	PV Array	Battery Bank	Total Cost \$
29	2620	7446	20.5154 M

Table 5 Optimal size of interruptible and uninterruptible loads.

Interruptible Loads (kWh)	Uninterruptible Loads (kWh)
230	40.968

Table 6 Amount of some notions of reliability.

LOLE (hr/yr)	LPSP	LOEE (MWh/yr)	ELF
4	0.016×10^{-3}	0.04968	0.01×10^{-3}

We demonstrated that by removing the fuel cell, micro-grid reliability does not decrease; the optimal size of wind turbine, PV arrays and battery storage increases to produce required power in the micro-grid. This is because output power of wind turbines and PV arrays has fluctuations.

5 Conclusion

In this paper a novel intelligent method is applied to the problem of sizing in a micro-grid considering reliability parameters, forced outage rate, uncertainty of wind and PV power and required demand in the micro-grid, and interruptible and uninterruptible loads for micro-grid. When produced power in the micro-grid cannot meet demand, first interruptible and then uninterruptible loads are interrupted. Variations in wind speed and solar radiation is the main problem with solar and wind energy. Utilization of battery storage and fuel cell as a backup will solve this problem. Fuel cell is a reliable backup for the micro-grid. Output power of fuel cell is constant so, in the absence of the fuel cells, the number of PV and wind units will increase to compensate the output power of fuel cell.

References

- [1] H. Aki, "The penetration of micro CHP in residential dwellings in Japan", *IEEE Power Engineering Society General Meeting*, pp. 1-4, June. 2007.
- [2] H. X. Liang and Q. W. Wang, "Evaluation of energy efficiency for a CCHP system with available microturbine", *In Proc. ASME Turbo Expo.*, Vol. 3, pp. 969-975, May. 2007.
- [3] H. Asano, H. Watanabe and S. Bando, "Methodology to Design the Capacity of a Microgrid", *IEEE International Conference on System of Systems Engineering*, pp. 1-6, 2007.
- [4] M. Gomez, A. Lopez and F. Jurado, "Optimal placement and sizing from standpoint of the investor of Photovoltaics Grid-Connected Systems using Binary Particle Swarm Optimization", *Applied Energy*, Vol. 87, No. 6, pp. 1911-1918, June 2010.
- [5] H. Asano and S. Bando, "Optimization of a microgrid investment and operation: energy saving effects and feasibility of ancillary service provision", *IEEE Transmission & Distribution Conference & Exposition: Asia and Pacific*, pp. 1-4, Oct. 2009.
- [6] Ch. L. Chen, Sh. Ch. Hsieh, T. Y. Lee and Ch. L. Lu, "Optimal integration of wind farms to isolated wind-Diesel energy system", *Energy Conversion and Management*, Vol. 49, No. 6, pp. 1506-1516, June. 2008.
- [7] H. Dagdougui, R. Mancinardi, A. Ouammi, M. Robba and R. Sacile, "Modeling and optimization of a hybrid system for the energy supply of a

- “Green” building”, *Energy Conversion and Management*, Vol. 64, pp. 351–363, Dec. 2012.
- [8] M. R. Al-Rashidi and M. F. Al-Hajri, “Optimal planning of multiple distributed generation sources in distribution networks: A new approach”, *Energy Conversion and Management*, Vol. 52, No. 11, pp. 3301–3308, Oct. 2011.
- [9] M. Alsayed, M. Cacciato, G. Scarcella and G. Scelba, “Multicriteria Optimal Sizing of Photovoltaic-Wind Turbine Grid Connected Systems”, *IEEE Transactions on Energy Conversion*, Vol. 28, No. 2, pp. 370-379, June 2013.
- [10] D. Q. Hung, N. Mithulananthan and R. C. Bansal, “Analytical Expressions for DG Allocation in Primary Distribution Networks”, *IEEE Trans. on Energy Conversion*, Vol. 25, No. 3, pp. 814-820, Sep. 2010.
- [11] T. K. Saha and D. Kastha, “Design Optimization and Dynamic Performance Analysis of a Stand-Alone Hybrid Wind–Diesel Electrical Power Generation System”, *IEEE Trans. on Energy Conversion*, Vol. 25, No. 4, pp. 1209-1217, 2010.
- [12] A. Roy, S. B. Kedare and S. Bandyopadhyay, “Optimum sizing of wind-battery systems incorporating resource uncertainty”, *Applied Energy*, Vol. 87, No. 8, pp. 2712–2727, 2010.
- [13] K. Zhou, J. A. Ferreira and S. W. H. de Haan, “Optimal energy management strategy and system sizing method for stand-alone photovoltaic-hydrogen systems”, *International Journal of Hydrogen Energy*, Vol. 33, No. 2, pp. 477–489, Jan. 2008.
- [14] S. M. Hakimi, S. M. Moghaddas-Tafreshi and H. HassanzadehFard, “Optimal sizing of reliable hybrid renewable energy system considered various load types”, *Journal of Renewable and Sustainable Energy*, Vol. 3, No. 6, Nov. 2011.
- [15] D. B. Nelson, M. H. Nehrir and C. Wang, “Unit sizing and cost analysis of stand-alone hybrid wind/PV/fuel cell power generation systems”, *Renewable Energy*, Vol. 31, No. 10, pp. 1641–1656, Aug. 2006.
- [16] W. X. Shen, “Optimally sizing of solar array and battery in a standalone photovoltaic system in Malaysia”, *Renewable Energy*, Vol. 34, No. 1, pp. 348-352, Jan. 2009.
- [17] E. I. Vrettos and S. A. Papathanassiou, “Operating Policy and Optimal Sizing of a High Penetration RES-BESS System for Small Isolated Grids”, *IEEE Transactions on Energy Conversion*, Vol. 26, No. 3, pp. 744–756, 2011.
- [18] A. Q. Jakhriani, Al-Khalid Othman, A. R. H. Rigit, S. R. Samo and Sh. A. Kamboh, “A novel analytical model for optimal sizing of standalone photovoltaic systems”, *Energy*, Vol. 46, No. 1, pp. 675–682, Oct. 2012.
- [19] R. Bornatico, M. Pfeiffer, A. Witzig and L. Guzzella, “Optimal sizing of a solar thermal building installation using particle swarm optimization”, *Energy*, Vol. 41, No. 1, pp. 31–37, May. 2012.
- [20] A. Kaabeche, M. Belhamel and R. Ibtiouen, “Sizing optimization of grid-independent hybrid photovoltaic/wind power generation system”, *Energy*, Vol. 36, No. 2, pp. 1214-1222, 2011.
- [21] Ch. Milan, C. Bojesen and M. P. Nielsen, “A cost optimization model for 100% renewable residential energy supply systems”, *Energy*, Vol. 48, No. 1, pp. 118–127, Dec. 2012.
- [22] E. Koutroulis, D. Kolokotsa, A. Potirakis and K. Kalaitzakis, “Methodology for optimal sizing of stand-alone photovoltaic/wind-generator systems using genetic algorithms”, *Solar Energy*, Vol. 80, No. 9, pp. 1072-1088, Sep. 2006.
- [23] G. B. Shrestha and L. Goel, “A study on optimal sizing of stand-alone photovoltaic stations”, *IEEE Transactions on Energy Conversion*, Vol. 13, No. 4, pp. 373–378, Dec. 1998.
- [24] T. Y. Lee and N. Chen, “Determination of optimal contract capacities and optimal sizes of battery energy storage systems for time-of-use rates industrial customers”, *IEEE Trans. Energy Conv.*, Vol. 10, No. 3, pp. 562-568, Sep. 1995.
- [25] K. Manjunatha Sharma and K. P. Vittal, “A Heuristic Approach to Distributed Generation Source Allocation for Electrical Power Distribution Systems”, *Iranian Journal of Electrical & Electronic Engineering*, Vol. 6, No. 4, pp. 224-231, Dec. 2010.
- [26] R. K. Rajkumar, V. K. Ramachandaramurthy, B. L. Yong and D. B. Chia, “Techno-economical optimization of hybrid pv/wind/battery system using Neuro-Fuzzy”, *Energy*, Vol. 36, No. 8, pp. 5148-5153, Aug. 2011.
- [27] A. Rajendra Prasad and E. Natarajan, “Optimization of integrated photovoltaic–wind power generation systems with battery storage”, *Energy*, Vol. 31, No. 12, pp. 1943–1954, 2006.
- [28] M. A. Habib, S. A. M. Said, M. A. El-Hadidy and I. Al-Zaharna, “Optimization procedure of a hybrid photovoltaic wind energy system”, *Energy*, Vol. 24, No. 11, pp. 919–929, Nov. 1999.
- [29] P. Arun, R. Banerjee and S. Bandyopadhyay, “Optimum sizing of battery-integrated diesel generator for remote electrification through design-space approach”, *Energy*, Vol. 33, No. 7, pp. 1155–1168, Jul. 2008.
- [30] M. Padma Lalitha, V. C. Veera Reddy and N. Sivarami Reddy, “Application of Fuzzy and ABC Algorithm for DG Placement for Minimum Loss in Radial Distribution System”, *Iranian Journal of Electrical & Electronic Engineering*, Vol. 6, No. 4, pp. 248-257, Dec. 2010.

- [31] S. Jadid and S. A. Bahreyni, "A Stochastic Operational Planning Model for Smart Power Systems", *Iranian Journal of Electrical & Electronic Engineering*, Vol. 10, No. 4, pp. 293-303, Dec. 2014.
- [32] R. Dashti, Sh. Yousefi and M. Parsa Moghaddam, "Comprehensive efficiency evaluation model for electrical distribution system considering social and urban factors", *Energy*, Vol. 60, No. 1, pp. 53-61, Oct. 2013.
- [33] R. Dashti, S. Afsharnia and F. Ghaderi, "AGA (Asset Governance Assessment) for analyzing affect of subsidy on MC (Marginal Cost) in electricity distribution sector", *Energy*, Vol. 35, No. 12, pp. 4996-5007, Dec. 2010.
- [34] S. M. Hakimi, S. M. Moghaddas-Tafreshi and A. Kashefi, "Unit sizing of a stand-alone hybrid power system using particle swarm optimization (PSO)", *IEEE International Conference on Automation and Logistics*, pp. 3107-3112, Aug. 2007.
- [35] M. J. Khan, and M. T. Iqbal, "Pre-feasibility study of stand-alone hybrid energy systems for applications in Newfoundland", *Renewable Energy*, Vol. 30, No. 6, pp. 835-854, May. 2005.
- [36] <www.mahler-ags.com>
- [37] R. S. Garcia and D. Weisser, "A wind-diesel system with hydrogen storage: Joint optimization of design and dispatch", *Renewable Energy*, Vol. 31, No. 14, pp. 2296-2320, Nov. 2006.
- [38] Bagen and R. Billinton, "Evaluation of different operating strategies in small stand-alone power systems", *IEEE Transactions on Energy Conversion*, Vol. 20, No. 3, pp. 654-660, Sep. 2005.
- [39] R. Karki, and R. Billinton, "Reliability/Cost Implications of PV and Wind Energy Utilization in Small Isolated Power Systems", *IEEE Transactions on Energy Conversion*, Vol. 16, No. 4, pp. 368-373, Dec. 2001.
- [40] M. Marchesoni and S. Savio, "Reliability Analysis of a Fuel Cell Electric City Car", *IEEE European Conference on Power Electronics and Applications*, pp. 10, 2005.
- [41] K. Methaprayoon and Ch. Yingvivananpong, "An Integration of ANN Wind Power Estimation Into Unit Commitment Considering the Forecasting Uncertainty", *IEEE Transactions on Industry Application*, Vol. 43, No. 6, pp. 1441-1448, Nov./Dec. 2007.
- [42] L. Xiangjun, Y. J. Song and S. B. Han, "Frequency control in micro-grid power system combined with electrolyzer system and fuzzy PI controller", *Journal of Power Sources*, Vol. 180, No. 1, pp. 468-475, May. 2008.



Hamid Hassanzadeh Fard was born in 1985 in Miyaneh, Iran. He received the B.Sc. degree in electrical engineering from K.N.Toosi University of Technology, Tehran, in 2008 and M.Sc. degree from K.N.Toosi University of Technology, Tehran in 2011. Since 2012, he is pursuing the Ph.D. degree in Iran University of Science and Technology.

His research interests include power quality, micro-grid, smart grid, renewable energy, distributed generation, optimization etc.



Seyed Amirhossein Bahreyni was born in 1988 in Mashhad, Iran. He received the B.Sc. degree in electrical engineering from Ferdowsi University of Mashhad, in 2010 and M.Sc. degree from Iran University of Science and Technology, Tehran in 2012. Since 2012, he is pursuing the Ph.D.

degree in Iran University of Science and Technology. His research interests include smart grid, DG expansion planning, transmission expansion planning, stochastic optimization.



Reza Dashti received his B.Sc. and M.Sc. degrees in Electrical Engineering in 2003 and 2005 and the Ph.D. degree in Electrical Engineering from Tehran University, in 2011. Currently, He is an Assistant Professor in Electrical Engineering Department of IUST, Tehran, Iran. His research interests

are in Distribution System Asset Management and Security. He has published more than 10 Journal papers and 40 conference papers.



Heidar Ali Shayanfar received his B.Sc. and M.Sc. degrees in Electrical Engineering in 1973 and 1979 and the Ph.D. degree in Electrical Engineering from Michigan State University, U.S.A., in 1981. Currently, He is a Full Professor in Electrical Engineering Department of IUST, Tehran, Iran.

His research interests are in the application of artificial intelligence to power system control design, area of smart grid, dynamic load modeling, power system observability studies and voltage collapse. He has published more than 210 Journal papers and 285 conference papers. He is a member of Iranian Association of Electrical and Electronic Engineers (IAEEE) and IEEE.