

A Comparison Between Electrical Circuit and Finite Element Modeling Methods for Performance Analysis of a Three-Phase Induction Motor under Voltage Unbalance

A. Ebadi*, M. Mirzaie* and S. A. Gholamian*

Abstract: Induction motor is the most popular load in the industry, it is very important to study about the effects of voltage quality on induction motor performance. One of the most important voltage quality problems in power system is voltage unbalance. This paper evaluates and compares two methods including finite element method (FEM) and equivalent electrical circuit simulation for investigation of the effects of voltage unbalance conditions on the performance of a three-phase induction motor. For this purpose, a three-phase squirrel cage induction motor is simulated using Finite Element Method and equivalent electrical circuit parameters of the FEM model is estimated by genetic algorithm. Then, some unbalanced voltages are applied on the FEM model of the Motor and the resulted power and losses are compared with calculated values using equivalent electrical circuit simulation in same voltage conditions.

Keywords: Three-Phase Induction Motor, Finite Element Method, Genetic Algorithm, VUF, Unbalanced Voltage.

1 Introduction

Power system unbalance, due to uneven distribution of single-phase loads in three-phase power systems, asymmetrical transformer winding impedances, open-Y, open- Δ transformer banks, incomplete transposition of transmission lines, blown fuses on three-phase capacitor banks and so on, has been bothering many power companies [1]. Therefore, performance analysis of equipments in power systems under voltage unbalance condition is important.

Because of various techno-economic benefits, Induction Motors (IMs) are widely employed in industrial, commercial and residential applications for energy conversion purposes. Based on U.S. Department of energy, industrial motors consume 70% of electricity, and induction motors are almost 80% of the loads in a typical industry [2]. Although an induction motor is designed and built to work in balanced condition most of them are connected directly to the electric power distribution system and they are exposed to unbalanced voltages and consequently, the performance evaluation of three-phase induction motor under voltage unbalance conditions is vital.

According to above description, many authors attempt to evaluate unbalanced voltage operation of motors throughout last century. In a classic paper published in 1954, equations for calculating the positive- and the negative-sequence parameters of the induction machine were presented by Williams that may be used in the equivalent electrical circuit to analyze machine performance under voltage unbalance conditions [3]. Effects of unbalanced voltages on the efficiency [4], derating in the machine [5], increase of losses, and the undesirable effects on the insulation life [6], and life reduction due to temperature rise [7, 8] are some other contributions in this area. Note that, up to now, most of the authors have used experimental test and/or Fortescue symmetrical component developed by Williams for performance analysis of induction motors under unbalanced voltage. Also Finite Element Method as a powerful tool has been used to simulate electrical machines in recent years. In fact, high accurate electrical machine performance simulation by this method is possible just in presence of advanced computers.

This paper evaluates and compares two mentioned simulation methods including Finite Element Method and the equivalent electrical circuit (classic method) for the performance analysis of three-phase induction motor. Achieving this aim, a 2.2 kW, 380 V three-phase squirrel cage induction motor has been simulated using Maxwell 12.1 software based on FEM [9], and parameters of the equivalent electrical circuit of the

Iranian Journal of Electrical & Electronic Engineering, 2012.

Paper first received 29 Aug. 2011 and in revised form 17 Mar. 2012.

* The Authors are with the Department of Electrical and Computer Engineering of Babol University of Technology, P. O. Box 484, Babol, Iran.

E-mails: a.ebadi@stu.nit.ac.ir, mirzaie@nit.ac.ir, gholamian@nit.ac.ir

simulated model is estimated using genetic algorithm. Also power and losses of the machine are calculated under voltage unbalance using FEM and equivalent electrical circuit and then the results are compared.

2 Simulation using Time-Stepping FEM

In this section, a three-phase squirrel cage induction motor is simulated using finite element and its performance under balanced and rated voltage is analyzed.

2.1 Analysis Model

Fig. 1 and Table. 1 show the meshed quarter cross section of the analyzed motor and its brief specifications, respectively.

2.2 Time-Stepping 2D FEM

In this work, time-stepping FEM is used for the

Table 1 Technical data of the IM

Item	Value	Item	Value
Rated Voltage (V)	380	Connection	Y
Rated Output Power (W)	2200	Stator outer diameter (cm)	15
Frequency (Hz)	50	Rotor outer diameter (cm)	9
Rated current (A)	5.3	Core length (cm)	9
Power factor	0.8	Air gap (cm)	0.03
Rated speed (rpm)	1410	All laminations type	M530-50A
Pole number	4	turns No. in stator coil	44

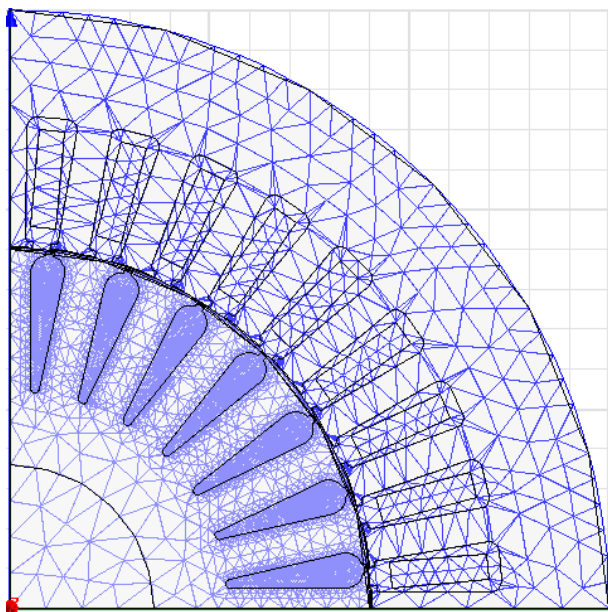

Fig. 1 Meshed model of the IM.

analysis of the magnetic field. For the time-stepping FEM, time step should be fixed and the input voltage should be defined at each time step. The governing equation for two-dimensional (2-D) FE analysis is given by [10, 11]:

$$\frac{\partial}{\partial x} \left(\frac{1}{\mu} \frac{\partial A}{\partial x} \right) + \frac{\partial}{\partial y} \left(\frac{1}{\mu} \frac{\partial A}{\partial y} \right) = \sigma \frac{dA}{dt} - J_0 \quad (1)$$

In above equation, μ is the permeability, A is the component of magnetic vector potential, σ is the conductivity of the materials, and J_0 is the exciting current density of the stator winding. The voltage equation per each phase is:

$$V_a = I_a R_a + L_e \frac{dI_a}{dt} + \frac{d\Phi_a}{dt} \quad (2)$$

where V_a , I_a , R_a , Φ_a and L_e are the input voltage, the current, the resistance, the flux linkage of each phase and the end-coil inductance, respectively. Note that, L_e is calculated using RMXprt toolbox in Maxwell 12.1.

2.3 Calculation of the Copper Loss

The stator winding and the conductor bar losses are calculated using FEM. The conductor bar loss (W_R) can be Calculated as follows [10, 11]:

$$W_R = I^2 R = \sigma \bar{E}^2 \Delta s \cdot L \quad (3)$$

$$\nabla \times \bar{A} = \bar{B} \quad (4)$$

$$\nabla \times \bar{E} = \frac{\partial \bar{B}}{\partial t} = -\nabla \times \frac{\partial \bar{A}}{\partial t} \quad (5)$$

in which, B , E , σ and $\Delta s \cdot L$ are magnetic flux density, Electric field intensity, the rotor bar conductivity and an element volume in the conductor bars, respectively.

2.4 Calculation of the Core Loss

According to traditional ac machine theory, iron loss in watts per kilogram can be calculated in each element using Eq. (6) and therefore total iron loss would be obtained from the summation of iron losses in the all elements.

$$P_c = P_h + P_e = K_h f B_m^\alpha + K_e f^2 B_m^2 \quad (6)$$

In the above equation, P_h and P_e are respectively, hysteresis loss component and eddy current component, both in watts per kilogram. B_m and f are the peak value of the flux density and the frequency, respectively. K_h , K_e and α are constants provided by the manufacture.

2.5 Dynamic Mechanical Equation of the Machine

The dynamic mechanical equation of machine is [12]:

$$T - T_{LOAD} = J \frac{d\omega}{dt} + B_m \omega \quad (7)$$

In order to realize the variations of the load under voltage unbalance conditions, a linear load torque with the following equation has been considered as the load:

$$T_{LOAD} = \left(\frac{T_{FL}}{\omega_{rated}} \right) \times \omega \quad (8)$$

In Eq. (8), T_{FL} is full load torque, ω_{rated} , ω are speed and rated speed of the machine, respectively.

2.6 Simulation Setting

Transient solver with step time equal to 10^{-4} s has been used in simulations and quarter cross section of motor is meshed with 9688 of triangles. Simulation of each cycle (0.02 s) consumed 236.3 seconds of time in a computer with 3 GHz core 2 Duo CPU and 2 Giga Byte of DDR2 Ram. It must be noted, Core magnetic behavior has been considered to nonlinear magnetic curve for M 530-50A lamination.

3 Results under Rated Voltage Condition

The distribution of the magnetic flux density (in steady state) and the stator currents under rated condition resulted by FEM simulation are shown in the Figs. 2 and 3, respectively. The calculated input and output powers, losses, power factor, rms value of the current and rotor speed are tabulated in Table. 2. Note that, all mentioned values are for steady state condition. By comparison the calculated values of the output power, the current, the power factor and the rotor speed and the considering rated values of the machine (that are shown in Table. 1), it can be seen the simulated model is accurate enough to use. It must be noted that the stray loss is ignored in all calculations at this work.

4 Parameter Estimation using Genetic Algorithm

In this section the needed fitness function for parameter estimation of the simulated motor is obtained and it has been minimized using genetic algorithm.

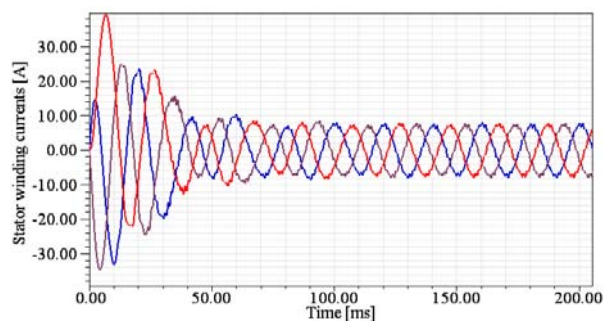

Fig. 2 Stator winding currents under rated voltage condition.

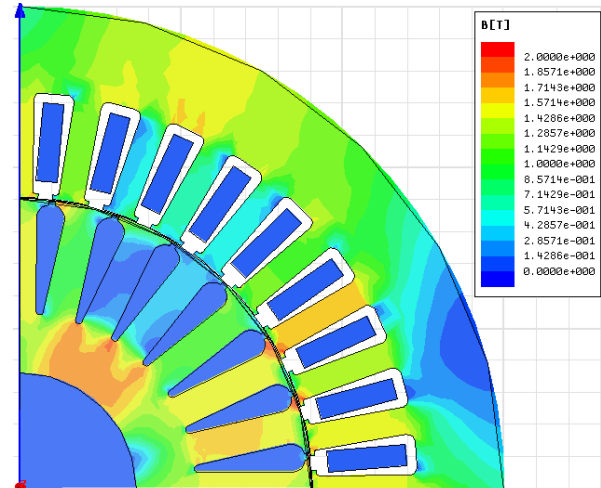

Fig. 3 The steady state distribution of the magnetic flux density under rated voltage condition.

Table 2 The calculated steady state results by FEM under rated voltage condition.

Stator current (A)	5.156	Core loss (W)	33.41
Power factor	0.796	Rotor copper loss (W)	137.3
Input power (W)	2700.45	Speed (rpm)	1406.6
Stator copper loss (W)	319.9	Output power (W)	2189

4.1 Fitness Function Determination

Fig. 4 shows the induction motor equivalent circuit. There are five unknown parameters in this circuit, namely: stator leakage reactance X_s , core loss resistance R_c , magnetizing reactance X_m , rotor leakage reactance X_r and rotor resistance R_r . Note that, the stator resistance or R_s is assumed to be determined according to Eq. (2).

The used objective function in this work is the average error of the input current I_s , the input active power P_{in} , the input reactive power Q_{in} , the core loss P_{Core} and the rotor copper loss $P_{Cu,r}$, i.e.:

$$f_1 = \left| \frac{I_{s-FEM} - I_{s-EC}}{I_{s-FEM}} \right| \times 100 \quad (9)$$

$$f_2 = \left| \frac{P_{in-FEM} - P_{in-EC}}{P_{in-FEM}} \right| \times 100 \quad (10)$$

$$f_3 = \left| \frac{Q_{in-FEM} - Q_{in-EC}}{Q_{in-FEM}} \right| \times 100 \quad (11)$$

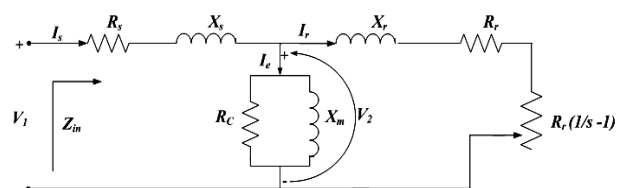

Fig. 4 Induction motor equivalent circuit.

$$f_4 = \left| \frac{P_{Core-FEM} - P_{Core-EC}}{P_{Core-FEM}} \right| \times 100 / P_{Core-FEM} \quad (12)$$

$$f_5 = \left| \frac{P_{Cur-FEM} - P_{Cur-EC}}{P_{Cur-FEM}} \right| \times 100 / P_{Cur-FEM} \quad (13)$$

Note that, indexes of FEM and EC shows the calculation method of mentioned values, i.e., the Finite Element Method and the Electrical Circuit. It must be noted that the values resulted from Finite Element Method can be found in Table 2. Based on above description, the fitness function to minimize is:

$$Error = \sum_{i=1}^5 f_i \quad (14)$$

4.2 Genetic Algorithm

The genetic algorithm is a method for solving both constrained and unconstrained optimization problems that is based on natural selection, the process that drives biological evolution. The genetic algorithm repeatedly modifies a population of individual solutions. At each step, the genetic algorithm selects individuals at random from the current population to be parents and uses them to produce the children for the next generation. Over successive generations, the population "evolves" toward an optimal solution.

4.3 Fitness Minimization using Genetic Algorithm

The fitness function is minimized using GA tool in MATLAB environment. To run the GA tool, a population of 1000 individuals was selected. Crossover factor is set to 0.8 and selection method is roulette wheel. The other genetic operators have been selected according to default setting in GA tool. Note that, constrains of the parameters are as follows:

$$\begin{aligned} 2\Omega \leq X_s \leq 3.2\Omega, \\ 2000\Omega \leq R_c \leq 5000\Omega, \\ 70\Omega \leq X_m \leq 75\Omega, \\ 5\Omega \leq X_r \leq 7\Omega, \\ 2.5\Omega \leq R_r \leq 3.2\Omega \end{aligned} \quad (15)$$

The estimated parameters of the machine are shown in Table. 3. These parameters can be employed in positive- and negative-sequence electrical circuit of the studied induction motor.

5 A Comparison of Two Methods

After a review on symmetrical component theory at this section, two mentioned simulation methods including Finite Element Method and the equivalent electrical circuit for the performance analysis of three-phase induction motor under voltage unbalance are compared.

Table 3 The estimated parameters by genetic algorithm.

X_s (Ω)	R_c (Ω)	X_m (Ω)	X_r (Ω)	R_r (Ω)
2.41	3425.14	70.869	5.035	3.008

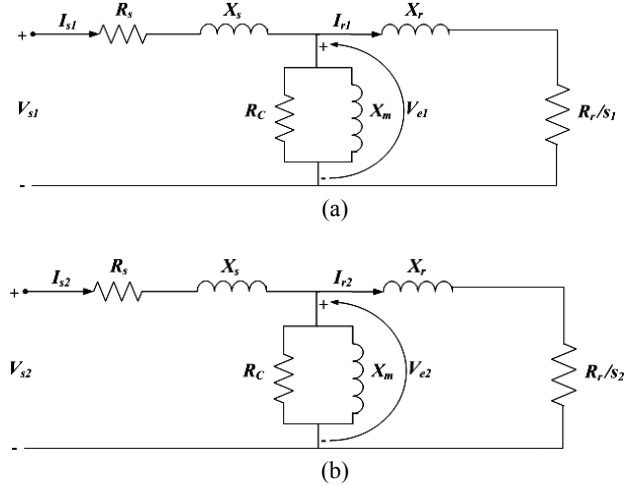

Fig 5 Equivalent electrical circuits (a) positive-sequence (b) negative-sequence.

5.1 Symmetrical Component Theory

Analysis of a three-phase induction motor operating under unbalanced voltage using symmetrical component theory requires positive- and negative-sequence equivalent circuit, as it is shown in Fig. 5.

Each circuit performs both positive- and negative-sequence circuits. The load resistance defined by positive- and negative-sequence slips is the only difference between the circuits. Positive- and negative-sequence slips are $s_1 = s$ and $s_2 = 2 - s$, respectively. Slip s is:

$$s = \left(\frac{n_s - n_r}{n_r} \right) \quad (16)$$

where n_s is synchronous speed and n_r is rotor speed.

Let V_{sa} , V_{sb} , and V_{sc} are the phase voltages of the stator. The corresponding zero-, positive-, and negative-sequence voltages (V_{s0} , V_{s1} , and V_{s3}) are given by

$$\begin{bmatrix} V_{s0} \\ V_{s1} \\ V_{s2} \end{bmatrix} = \frac{1}{3} \begin{bmatrix} 1 & 1 & 1 \\ 1 & a & a^2 \\ 1 & a^2 & a \end{bmatrix} \begin{bmatrix} V_{sa} \\ V_{sb} \\ V_{sc} \end{bmatrix} \quad (17)$$

where $a = e^{j(2\pi/3)}$ is the Fortescue operator. Note that, IEC definition for voltage unbalance or voltage unbalance factor (VUF) can be calculated as follows:

$$VUF = \left| \frac{V_{s2}}{V_{s1}} \right| \times 100 \quad (18)$$

Considering mentioned equivalent circuits, phase stator and rotor currents must be used to calculate the stator and the rotor losses. The phase currents are determined by performing the transformation back. Transforming the stator and rotor currents using the Fortescue matrix can be seen in Eqs (19) and (20), respectively.

$$\begin{bmatrix} I_{sa} \\ I_{sb} \\ I_{sc} \end{bmatrix} = \begin{bmatrix} 1 & 1 & 1 \\ 1 & a^2 & a \\ 1 & a & a^2 \end{bmatrix} \begin{bmatrix} I_{s0} \\ I_{s1} \\ I_{s2} \end{bmatrix} \quad (19)$$

$$\begin{bmatrix} I_{ra} \\ I_{rb} \\ I_{rc} \end{bmatrix} = \begin{bmatrix} 1 & 1 & 1 \\ 1 & a^2 & a \\ 1 & a & a^2 \end{bmatrix} \begin{bmatrix} I_{r0} \\ I_{r1} \\ I_{r2} \end{bmatrix} \quad (20)$$

In Eqs. (19) and (20), there are non zero-sequence currents ($I_{s0} \neq I_{r0} = 0$) because of the motor connection in delta or ungrounded wye.

Based on the above description, the stator and rotor copper losses of the motor are:

$$P_{CU-s} = R_s (|I_{sa}|^2 + |I_{sb}|^2 + |I_{sc}|^2) \quad (21)$$

$$P_{CU-r} = R_r (|I_{ra}|^2 + |I_{rb}|^2 + |I_{rc}|^2) \quad (22)$$

The core loss can be calculated with:

$$P_{Core} = \frac{3}{R_c} (|V_{e1}|^2 + |V_{e2}|^2) \quad (23)$$

Finally, input active power of the motor (P_{in}) and its impure output power (P_{out}) are:

$$P_{in} = 3 \operatorname{Re} [V_{s1} I_{s1}^* + V_{s2} I_{s2}^*] \quad (24)$$

$$P_{out} = P_1 + P_2 = 3 |I_{r1}|^2 \left(\frac{1-s_1}{s_1} \right) R_r + 3 |I_{r2}|^2 \left(\frac{1-s_2}{s_2} \right) R_r \quad (25)$$

5.2 Performance Analysis of the IM under Voltage Unbalance Conditions

For the purposes of this paper IEC definition of voltage unbalance has been selected to be used. But this is clear that there are many unbalanced voltages with the same VUF [13]. Therefore, here the average terminal voltage of the machine and their positive-sequence component are considered to be equal to the rated voltage and the VUF varies from 1% to 6% [14]. By applying these voltages, performance of the machine is analyzed using FEM simulation and equivalent electrical circuit method, and then results of two methods are compared in this section.

Values of calculated input/output powers, copper losses and core loss using two methods under mentioned voltages are shown as charts in Figs. 6, 7 and 8, respectively. Note that, results of power and losses for unbalanced conditions have been normalized with the corresponding values for the balanced condition (FEM results). According to Fig. 6, two methods predict the output power under mentioned unbalance conditions experiences negligible reduction by increasing VUF and

the input power increases by raising VUF. Increasing of the stator and the rotor copper losses with VUF increasing can be seen in Fig. 7.

According to Fig. 8, variation of the core loss in voltage unbalance condition with the same positive-sequence voltage is negligible. Regular reduction of efficiency by increasing VUF can be seen in Fig. 9. Based on these Figures, the results derived from two methods are too close, but for the rotor copper losses,

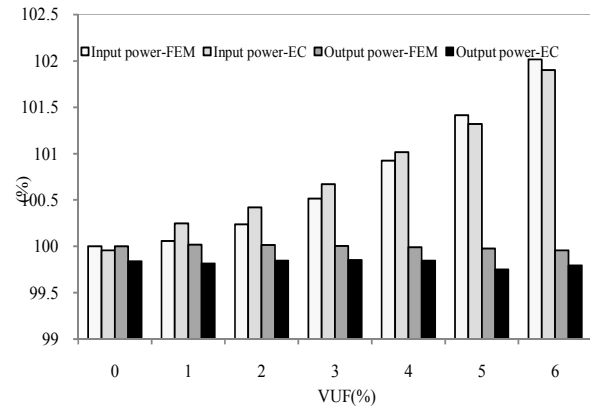

Fig. 6 Input/output powers under unbalanced voltages.

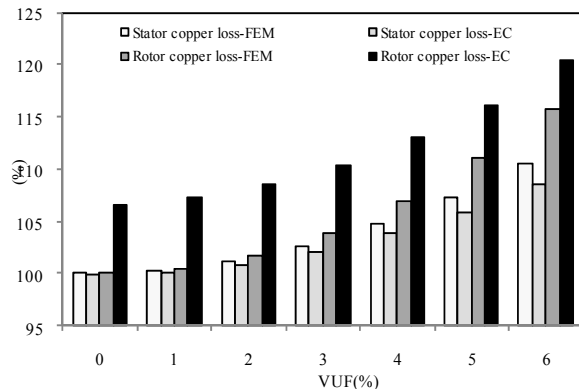

Fig. 7 Copper losses under unbalanced voltages.

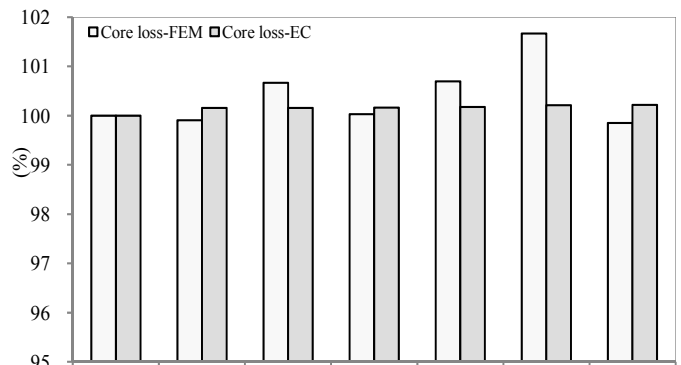

Fig. 8 Core loss under unbalanced voltages.

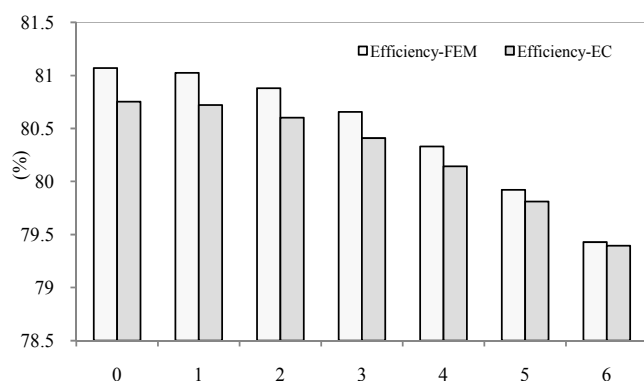

Fig. 9 Efficiency under unbalanced voltages.

the difference is relatively more than others which is due to error during the parameter estimation process regarding to results in balanced conditions (VUF=0%).

6 Conclusion

In this work, Equivalent Electrical Circuit and Finite Element Method as two modeling methods of three-phase induction motor simulation have been studied and compared based on its performance analysis under voltage unbalance. Also in order to have a justly comparison, the used electrical circuit parameters have been estimated by Genetic Algorithm using balanced voltage condition FEM results. Thus, this estimation ensures that similar results can be achieved by both methods under balanced voltage. Studying of calculated power, losses and efficiency of machine under different unbalanced voltage conditions using Electrical Circuit and FEM show the fact that approximately same and closed results can be achieved by two methods. Sure, FEM results include more details, but it is a complicated and time consuming method compared to Electrical Circuit simulation. Totally, Equivalent Electrical Circuit Simulation is more appropriate to analyze operating performance of three-phase induction machine under unbalanced voltages because of its more simplicity, lower simulation time and relatively suitable accuracy.

Acknowledgment

The authors would like to thank Mr. Rahmani and Mr. Setareh (R&D management office of Motogen Corporation, Tabriz, Iran) for providing data of the studied three-phase induction motor.

References

[1] Jouanne A. von, and Banerjee B., "Assessment of Voltage Unbalance", *IEEE Transactions on Power Delivery*, Vol. 16, No. 4, pp. 782-790, Oct. 2001.

[2] Souto O., Oliveira J., and Neto L., "Induction motors thermal behavior and life expectancy under nonideal supply conditions", *Ninth International conference on Harmonics and Quality of Power*, Vol. 3, pp. 899-904, Oct. 2000.

[3] Williams J. E., "Operation of 3-Phase Induction Motors on Unbalanced Voltages", *AIEE Trans.*, Vol. 73, pt. III-A, pp. 125-133, Jan. 1954.

[4] Lee C. Y., "Effects of Unbalanced Voltage on the Operation Performance of a Three-phase Induction Motor", *IEEE Transactions on Energy Conversion*, Vol. 14, No. 2, pp. 202-208, June 1999.

[5] Anwari M. and Hiendro A., "New Unbalance Factor for Estimating Performance of a Three-Phase Induction Motor With under and Overvoltage Unbalance", *IEEE Transactions on Energy Conversion*, Vol. 25, No. 3, pp. 619-625, Sept. 2010.

[6] Pillay P. and Manyage M., "Loss of Life in Induction Machines Operating With Unbalanced Supplies," *IEEE Transactions on Energy Conversion*, Vol. 21, No. 4, pp. 813-822, Dec. 2006.

[7] Gnaciński P., "Windings Temperature and Loss of Life of an Induction Machine Under-Voltage Unbalance Combined With Over- or Undervoltages", *IEEE Transactions on Energy Conversion*, Vol. 23, No. 2, pp. 363-371, June 2008.

[8] Gnacinski P., "Effect of unbalanced voltage on windings temperature, operational life and load carrying capacity of induction machine", *Energy Conversion and Management*, Vol. 49, No. 4, pp. 761-770, April 2008.

[9] Ansoft, Maxwell Software, Version 12.1.

[10] Ebadi A., Mirzaie M. and Gholamian S. A., "Employing Finite Element Method to Analyze Performance of Three-Phase Squirrel Cage Induction Motor under Voltage Harmonics", *Research Journal of Applied Sciences, Engineering and Technology*, Vol. 3, No. 10, pp. 1209-1213, Oct. 2011.

[11] Lee J. J., Kim Y. K., Nam H., Ha K. H., Hong J. P. and Hwang D. H., "Loss Distribution of Three-Phase Induction Motor Fed by Pulsewidth-Modulated Inverter", *IEEE Transactions on Magnetics*, Vol. 40, No. 2, pp. 762-765, March 2004.

[12] Krause P.C., "Analysis of Electric Machinery", McGraw-Hill, 1986, New York.

[13] Faiz J., Ebrahimpour H. and Pillay P., "Influence of Unbalanced Voltage on the Steady-State Performance of a Three-Phase Squirrel-Cage Induction Motor", *IEEE Transactions on Energy Conversion*, Vol. 19, No. 4, pp. 657-662, Dec. 2004.

[14] Ebadi A., Mirzaie M. and Gholamian S. A., "Torque Analysis of Three-Phase Induction Motor Under Voltage Unbalance Using 2D Fem", *International Journal of Engineering Science and Technology*, Vol. 3, No. 2, pp. 871-876, Feb. 2011.



Ali Ebadi was born in Sari, IRAN, in 1984. He received his B.Sc. and M.Sc. degrees both in Electrical Engineering from Noshirvani Institute of Technology, University of Mazandaran, Babol, Iran in 2007 and Babol Noshirvani University of Technology, Babol, Iran in 2011, respectively. His research interests

include Power System Analysis, power electronics and its applications in power systems and simulation and modeling of electrical machines.



Mohammad Mirzaie was born in GhaemShahr, Iran in 1975. He Obtained B.Sc. and M.Sc. Degrees in Electrical Engineering from University of Shahid Chamran, Ahvaz, Iran and Iran University of Science and Technology, Tehran, Iran in 1997 and 2000 respectively and PhD Degree in Electrical Engineering from Iran

University of Science and Technology in 2007. He worked as an Assistant Professor in the electrical and computer engineering faculty of Babol University of Technology since

2007. His research interests include life management of high voltage equipments, high voltage engineering, intelligence networks for internal faults assessment in equipments and studying of insulation systems in transformers, cables, generators, breakers, insulators, electrical motors and also overhead transmission lines.



Sayyed Asghar Gholamian was born in Babolsar, Iran, in 1976. He received his B.Sc. degree in electrical engineering from K.N.Toosi University of Technology, Tehran, Iran in 1999 and M.Sc. degree in electric power engineering (electrical machines) from university of Mazandaran, Babol, Iran in 2001. He also received the Ph.D degree

in electrical engineering from K.N.Toosi University of Technology, Tehran, Iran in 2008. He is currently an assistant professor in the department of Electrical and Computer Engineering at the Babol University of Technology, Babol, Iran. His research interests include power electronic and design, simulation, modeling and control of electrical machines (motor, generator and transformer).