



# Improved Optimization Process for Nonlinear Model Predictive Control of PMSM

A. Younesi\*, S. Tohidi\*(C.A.) and M. R. Feyzi\*

**Abstract:** Model-based predictive control (MPC) is one of the most efficient techniques that is widely used in industrial applications. In such controllers, increasing the prediction horizon results in better selection of the optimal control signal sequence. On the other hand, increasing the prediction horizon increase the computational time of the optimization process which make it impossible to be implemented in real time. In order to solve this problem, this paper presents an improved strategy in the field of nonlinear MPC (NMPC) of the permanent magnet synchronous motor (PMSM). The proposed method applies a sequence of reduction weighting coefficients in the cost function, over the prediction horizon. By using the proposed strategy, NMPC give a more accurate response with less number of prediction horizon. This means the computational time is reduced. It also suggests using an incremental algorithm to reduce the computational time. Performance of the proposed Nonlinear MPC (NMPC) scheme is compared with the previous NMPC methods via simulations performed by MATLAB/Simulink software, in permanent magnet synchronous motor drive system. The results show that the use of proposed structure not only lowers prediction horizon and hence computational time, but also it improves speed tracking performance and reduces electromagnetic torque ripple. In addition, using the incremental algorithm also reduces the computational time which makes it suitable for real-time applications.

**Keywords:** Nonlinear Model Predictive Control (NMPC), Optimal Control Signal Sequence, Receding Horizon Control, Computational Time, Permanent Magnet Synchronous Motor (PMSM).

## 1 Introduction

Permanent magnet synchronous machines (PMSMs) are extensively used in the servo drive systems and motion control applications due to their high power density, high efficiency, high torque to inertia ratio and high performance in wide range of speed [1,2]. Therefore, speed and position control of this machines has attracted attention in the recently published studies [3].

Due to the system nonlinearities and uncertainties,

conventional linear controllers which use the proportional-integral (PI) blocks in their cascade structure, cannot guarantee satisfactory performance of the PMSM drive system [4]. To overcome such problems and also for achieving high control performance, several control techniques have been developed for the PMSM. Among such control methods, field-oriented vector control (FOC) and direct torque control (DTC) are considered as the most popular methods [5]. DTC method is more efficient than FOC, because of its simple structure, fast dynamic response, and robustness against variations of the parameters. However, the classical DTC has some disadvantages, such as variable switching frequency and massive torque and flux ripples [6]. In [7], space vector modulation (SVM) is introduced to decrease the torque ripple when DTC is applied. It also fixes the switching frequency of inverter. A survey of DTC based method for AC motors driven by inverter is studied in [8].

Iranian Journal of Electrical & Electronic Engineering, 2018.

Paper first received 16 August 2017 and accepted 22 February 2018.

\* The authors are with the Faculty of Electrical and Computer Engineering, University of Tabriz, Tabriz, Iran.

E-mails: [ariayounesi@tabrizu.ac.ir](mailto:ariayounesi@tabrizu.ac.ir), [stohidi@tabrizu.ac.ir](mailto:stohidi@tabrizu.ac.ir) and [fezyi@tabrizu.ac.ir](mailto:fezyi@tabrizu.ac.ir).

Corresponding Author: S. Tohidi.

In the following, to improve the control performance of PMSM, many nonlinear control techniques, such as fuzzy logic control, adaptive control and sliding mode control (SMC) have been investigated. In [9], the fuzzy technique is used in a digital servo drive to increase dynamic response of the PMSM. A robust model reference adaptive control of PMSM is introduced in [10]. In [11,12], it is obtained that the use of SMC technique reduces the torque ripple and improves the control performance of PMSM drive system. However, it increases the switching frequency of inverter. Combinations of the mentioned methods are reported in [13-15]. Such nonlinear methods improve the performance of PMSM drive system. Discrete space vector modulation is proposed to improve the performance of the DTC in in [16,17]. This method reduces torque ripple and fixes the switching frequency. But, a complex lookup table is required.

To enhance the performance of nonlinear systems, the controllers should have high control flexibility, high dynamic response and high performance under different conditions. According to researches conducted in the recent years, one of the best methods that have attracted much attention in the field of power electronics and drive is model predictive control (MPC) [18,19]. The basic characteristic of MPC strategy is to use a model of the plant to predict the future behavior of system. This prediction takes place at each instant through an optimization process of a user-defined objective function over a prediction horizon ( $N_p$ ) [20]. Due to many benefits such as ability of control nonlinear and multivariable systems and also easily adding of desired constraints to the objective function, the MPC has grown both in industry and theoretical researches [18]. In [21], the speed ripple is reduced by using a cascade MPC structure. Also, a multiscale MPC cascade method is proposed for removing the gap between the planning and control in [22]. In [23,24], a combined MPC and DTC method which is called MPDTC is proposed for driving the PMSM. In [25], two PMSMs are simultaneously controlled by MPC method. Implementation of low cost architecture for an active front end rectifier is presented in [26]. In the MPC based methods, the main problem is the high computational burden of the online optimization which makes its real time implementation very hard. To overcome this problem, several strategies are proposed in literature. In [27], a model predictive direct speed control is introduced for a PMSM in which, the computational burden is reduced by forgoing several predictable modes. In [28] the online generalized predictive control is used to reduce the computational time. Adding nonlinearities and constrains to system, is very difficult in this strategy. In some other MPC methods which are reviewed in [29], some calculations are prevented by assuming the prediction horizon in the value of one. On the other hand, the fewer number of prediction horizon results in poor selection of the

control variables. In [30], another MPC method is proposed for a linear induction motor in which the use of an incremental algorithm is suggested for avoiding examining all the possible combinations over the control horizon ( $N_c$ ). The control horizon determines the number of decision variables ( $N_c \leq N_p$ ). In the studies, other strategies are proposed to reduce the switching frequency of inverter and to increase the precision of MPC. In [31,32], a simplified and computationally efficient lookup table base MPC for PMSM is proposed. But, this method utilizes a matrix converter to feed the PMSM. A cascaded predictive integral resonant controller is used for PMSM in [33]. A common MPC for PMSM considering open circuit fault is presented in [34]. In [35], MPC with field weakening controls the PMSM. In [36], a micro PMSM is controlled by MPC. A predictive speed control with short prediction horizon for PMSM is proposed in [37]. In [38], an improved NMPC method is used for PMSM. Applications of the MPC strategies in the power electronics and drive systems are reviewed in [18].

Generally, in all the previous NMPC, constant weighting coefficients are used only to tradeoff between the various goals in the cost function and the prediction steps are not weighted, in other words, they are equally weighted in the objective function. In such controllers, increasing the prediction horizon results in better selection of the optimal control signal sequence. But excessive increase in the prediction horizon, will make the implementation of the system impossible.

The main contribution of this paper is to propose a new optimization strategy for NMPC-based methods for PMSM. The proposed method along with the use of proper weight coefficients for various goals, applies a sequence of reduction weighting coefficients in the cost function, over the prediction horizon. By using the proposed strategy, NMPC give a more accurate response with less number of prediction horizon. This means the computational time is reduced. It also suggests using an incremental algorithm to more reduce the computational time.

In this paper, a novel MPC strategy is proposed for a nonlinear model of PMSM, in which the optimization process of traditional MPC is improved to reach the optimal value sooner. The proposed method along with the use of proper weight coefficients for various goals, applies a sequence of reduction weighting coefficients in the cost function, over the prediction horizon. By using the proposed strategy, NMPC give a more accurate response with less number of prediction horizon. This means the computational time is reduced. In addition, it suggests using an incremental algorithm to avoid using all the ineffective inputs over the prediction horizon ( $N_p$ ) to more reduce the computational time. By using this algorithm, when the value of objective function becomes more than the previous state in the prediction horizon, it is not necessary to continue the calculations for subsequent

predictions. This will increase the computational time. Hence, it significantly saves the time. Therefore, the use of proposed optimization structure and incremental algorithm reduces the computational burden of the standard MPC without reducing the chance of finding the optimum sequence.

The paper is organized as follows. Section 2 describes the nonlinear model of PMSM. The proposed NMPC is explained in Section 3. In Section 4, evaluation of the NMPC and simulation results are presented. Ultimately, conclusions are given in Section 5.

## 2 Modeling of PMSM System

### 2.1 Permanent Magnet Synchronous Motor

The continuous-time two-axis dynamic model of PMSM in the rotor reference frame has been introduced in [38]. Assuming  $i_d$ ,  $i_q$  and  $\omega$  as the system states and  $T_s$  as the sampling period, the discrete-time model can be obtained by using Forward-Euler method [22] as:

$$i_d(k+1) = i_d(k) + \frac{T_s}{L_d}(u_d(k) - Ri_d(k) - L_q\omega(k)i_q(k)) \tag{1}$$

$$i_q(k+1) = i_q(k) + \frac{T_s}{L_q}(u_q(k) - L_d\omega(k)i_d(k) - Ri_q(k) - \lambda\omega(k)) \tag{2}$$

$$\omega(k+1) = \omega(k) + \frac{T_s n_p}{K}(T_e(k) - T_l) \tag{3}$$

where  $u_d$  and  $u_q$  are the stator voltages (d, q axis, respectively),  $i_d$  and  $i_q$  are the stator currents (d, q axis, respectively),  $L_d$  and  $L_q$  are the stator inductance (d, q axis, respectively),  $R$  is the stator resistance,  $\lambda$  is the PM flux linkage,  $n_p$  is the number of pole pairs,  $K$  is the inertia coefficient,  $T_l$  is load torque,  $T_e$  is the electromagnetic torque and  $\omega$  is the electrical rotor speed.

Fig. 1 indicates the phasor diagram of a PMSM in the rotor reference frame. As shown in Fig. 1, by assuming  $i_d = 0$  the stator current space phasor will have only a

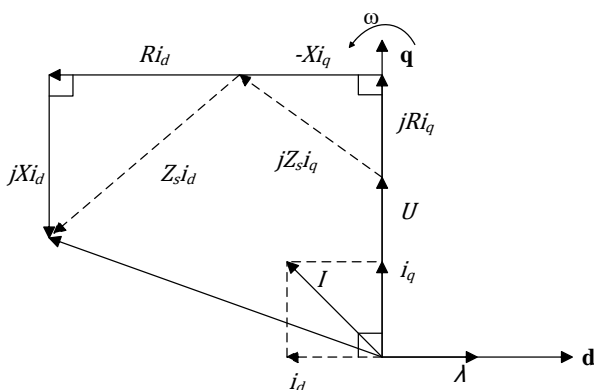

Fig. 1 Steady-state phasor diagram of PMSM.

quadrature axis component ( $i_q$ ). Thus, for any given stator current, the maximum torque is achieved by the current controller [20].

### 2.2 Voltage Source Inverter

As shown in Fig. 2, a three-phase two-level voltage source inverter (VSI) is used in the PMSM drive system. In order to protect the switches, the inverter allows only eight different switch position combinations as listed in Table 1. They consist of two inactive (zero-voltage) vectors and six active vectors.

### 3 Proposed NMPC

In the MPC based method, for each sample time (k) an optimal input vector sequence is obtained by optimization of a user-defined cost function. But, only the first control signal in the optimal sequence is applied to the system. Therefore, to have a good speed tracking together with a high dynamic response, the cost function is defined as:

$$J_1 = \sum_{j=1}^{N_p} P_i (\omega(k+j) - \omega^*(k+j))^2 \tag{4}$$

where  $J_1$  is the objective function,  $N_p$  is the prediction horizon,  $P_i$  is a weighting factor, the index  $i$  stands for the number of variables to be controlled, and  $\omega$  and  $\omega^*$  are the predicted and reference speed of the motor, respectively.

In the model-based predictive control approach, the future behavior of the controlled variables is predicted over a prediction horizon ( $N_p$ ) by using the system model. Then, at each sampling period, the voltage vector which minimizes the objective function is selected. Hence, the on-line optimization process is realized.

### 3.1 Optimization Process

According to the cost function of (4), all the prediction steps over the prediction horizon, are equally weighted in the cost function. Therefore, increasing the prediction horizon results in better selection of the optimal signal sequence but not optimal value for the first voltage vector. To overcome this problem, this paper proposes using a variable weighting factor ( $Q_j$ ) in

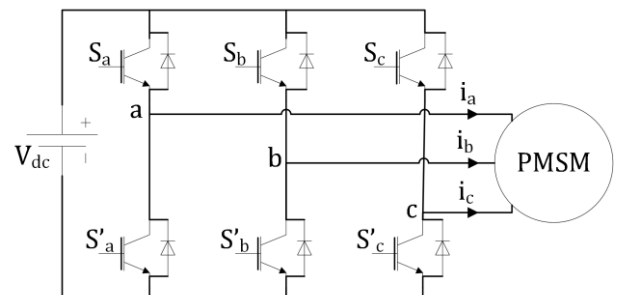

Fig. 2 Configuration of three phase VSI driving the PMSM.

the objective function which is decreased by increasing the prediction horizon. The proposed cost function is:

$$J_p = \sum_{j=1}^{N_p} Q_j P_i (\omega(k+j) - \omega^*(k+j))^2 \quad (5)$$

Algorithm 1 describes an example of the optimization process of the proposed cost function. According to Algorithm 1, the following sequence is obtained for selecting the proper weighting factor ( $Q_j$ ).

Proposed sequence to select the proper $Q_j$	
$Q_j = \frac{1}{2}, \frac{1}{3}, \frac{1}{4}, \dots, \frac{1}{j+1}, \dots, \frac{1}{N_p+1}$	$Q_1 > Q_2 > \dots > Q_j > \dots > Q_{N_p}$
$\Rightarrow Q_j = \frac{1}{j+1}$	$j = 1, 2, \dots, N_p$

As the cost function is the summation of the speed errors over the prediction horizon, the proposed  $Q_j$  makes the initial steps more effective in the objective

function. Thereupon, the control system gives more accurate response with a lower number of  $N_p$  which reduces the computational burden of the control system. In addition, the proposed NMPC utilizes an incremental algorithm in its structure in order to avoid examining all the possible input voltage vectors over the prediction horizon. The flow diagram of optimization of the proposed cost function by using incremental algorithm is shown in Fig. 3.

#### 4 Simulation Results

Simulation of the proposed drive system for a surface mounted PMSM (SPMSM) is performed using MATLAB/Simulink. Block diagram of the control system is shown in Fig. 4. The load torque is assumed to be measured. The specifications of SPMSM are included in Table 2. The sampling time is selected equal to 100  $\mu$ s. Performance of the proposed and classical NMPC are compared in the following.

**Table 1** Eight possible combinations of vsi switches (1: switch on, 0: switch off).

	STATE							
SWITCH	1	2	3	4	5	6	7	8
S <sub>a</sub>	1	1	1	1	0	0	0	0
S' <sub>a</sub>	0	0	0	0	1	1	1	1
S <sub>b</sub>	1	1	0	0	1	1	0	0
S' <sub>b</sub>	0	0	1	1	0	0	1	1
S <sub>c</sub>	1	0	1	0	1	0	1	0
S' <sub>c</sub>	0	1	0	1	0	1	0	1
Voltage Vectors	V <sub>1</sub>	V <sub>2</sub>	V <sub>3</sub>	V <sub>4</sub>	V <sub>5</sub>	V <sub>6</sub>	V <sub>7</sub>	V <sub>8</sub>
V <sub>a</sub>	0	$\frac{V_{dc}}{3}$	$\frac{V_{dc}}{3}$	$\frac{2V_{dc}}{3}$	$-\frac{2V_{dc}}{3}$	$-\frac{V_{dc}}{3}$	$-\frac{V_{dc}}{3}$	0

#### Algorithm 1 Optimization process of proposed cost function

1:	$n_p = 3; i = 1; p_l = 1; \text{instant} = k$	% Initialization
2:	$n = 1, 2, \dots, 8; (V_1, V_2, \dots, V_8)$	% The eight possible combinations of the inverter switches, as the possible input voltage vectors.
3:	<b>for</b> $n = 1 : 8$	
4:	<b>for</b> $j = 1 : N_p$	
5:	$J_p^n = \sum_{j=1}^{N_p} Q_j P_i (\omega(k+j) - \omega^*(k+j))^2$	% Cost function
	$J_p^n = Q_1 P_i (\omega(k+1) - \omega^*(k+1))$	% $Q_3, Q_2$ and $Q_1$ are the weighting factor where $Q_1 > Q_2 > Q_3 > 0$ .
	$+ Q_2 P_i (\omega(k+2) - \omega^*(k+2))$	
	$+ Q_3 P_i (\omega(k+3) - \omega^*(k+3))$	
6:	<b>end for</b>	
7:	<b>end for</b>	
8:	$\min (J_p^1, J_p^2, \dots, J_p^8)$	% It results optimal voltage vector sequence $[V_x, V_y, V_z]_{1 \times N_p}$ .
9:	Apply the $V_x$ to the motor.	% Applying the first value of the optimal sequence to the system.
10:	$k = k+1$ and go to line 3.	% Go to the next instant (k+1) and repeat the optimization

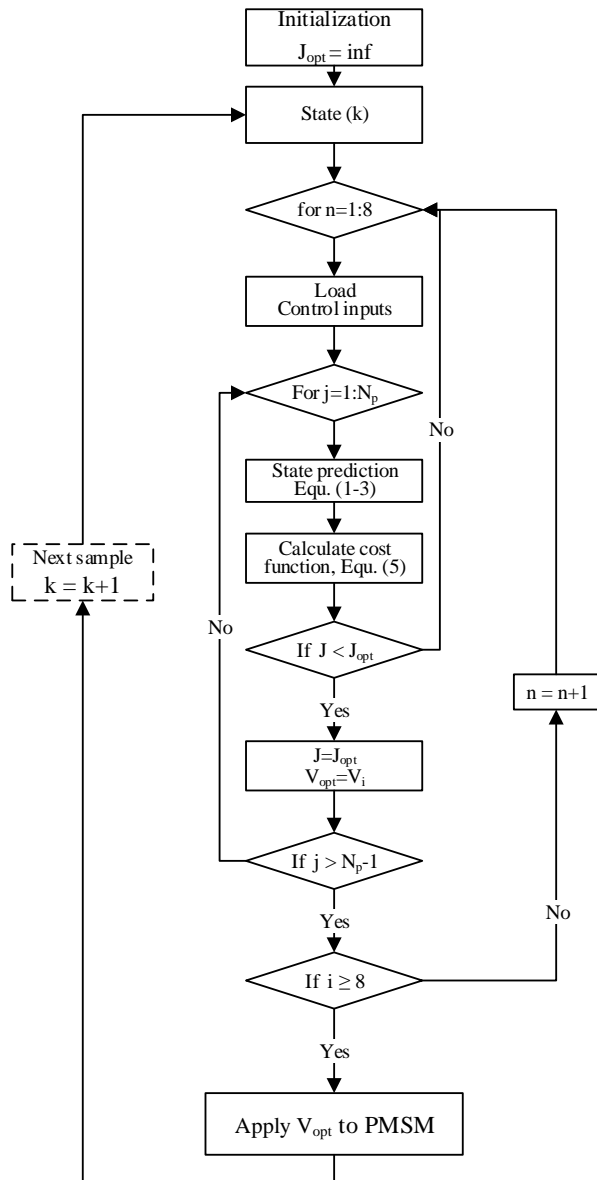

Fig. 3 Flow diagram of optimization process through incremental algorithm.

4.2 Tracking Performance

4.2.1 Speed Tracking Performance with Constant Load Torque

First, speed tracking performance of the proposed NMPC strategy is studied. The reference speed accelerates up to 1000 rpm in 0.05 s, while the load torque is equal to 5 Nm. Then, the reference speed is stepped from 1000 to 2300 rpm at  $t = 0.1$  s, and then comes back to 500 rpm at  $t = 0.15$  s. The comparison of proposed NMPC and classical NMPC for above mentioned steps in speed reference is shown in Fig. 5. As shown in this figure, a good speed tracking (without overshoots) of the PMSM start is achieved by the proposed NMPC and the classical one. But according to the waveforms of the Fig. 5, the proposed NMPC has

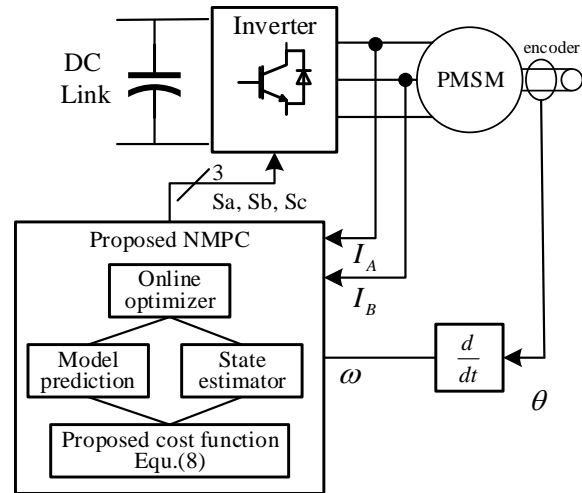

Fig. 4 Block diagram of the proposed drive system.

Table 2 Specifications of SPMSM.

Pole pairs $n_p$	4
Nominal speed $\omega$	2300 rpm
Rated torque $T_e$	10 Nm
Stator resistance $R_s$	457.8 m $\Omega$
Rotor resistance $R_r$	1654.8 m $\Omega$
Inductance $L_d$	1 mH
Inductance $L_q$	1 mH
PM flux linkage $\lambda$	33.4 mWb
Inertia coefficient	0.001469 kgm <sup>2</sup>

better tracking performance with smaller overshoots and faster dynamic response for step changes in the reference speed.

It should be noted that, the main difference of proposed NMPC with the classical one which are compared in simulation, is in the optimization process, while both methods use the same goals in the objective functions with the same weight coefficients. In order to investigate influence of the proposed cost function, the control specifications of proposed and classical NMPC are given in Table 3.

Obviously, in the MPC based methods, increasing the prediction horizon results in superior tracking performance. However, increasing the prediction horizon will increase the computational time. Table 3 reveals that the proposed cost function has caused the

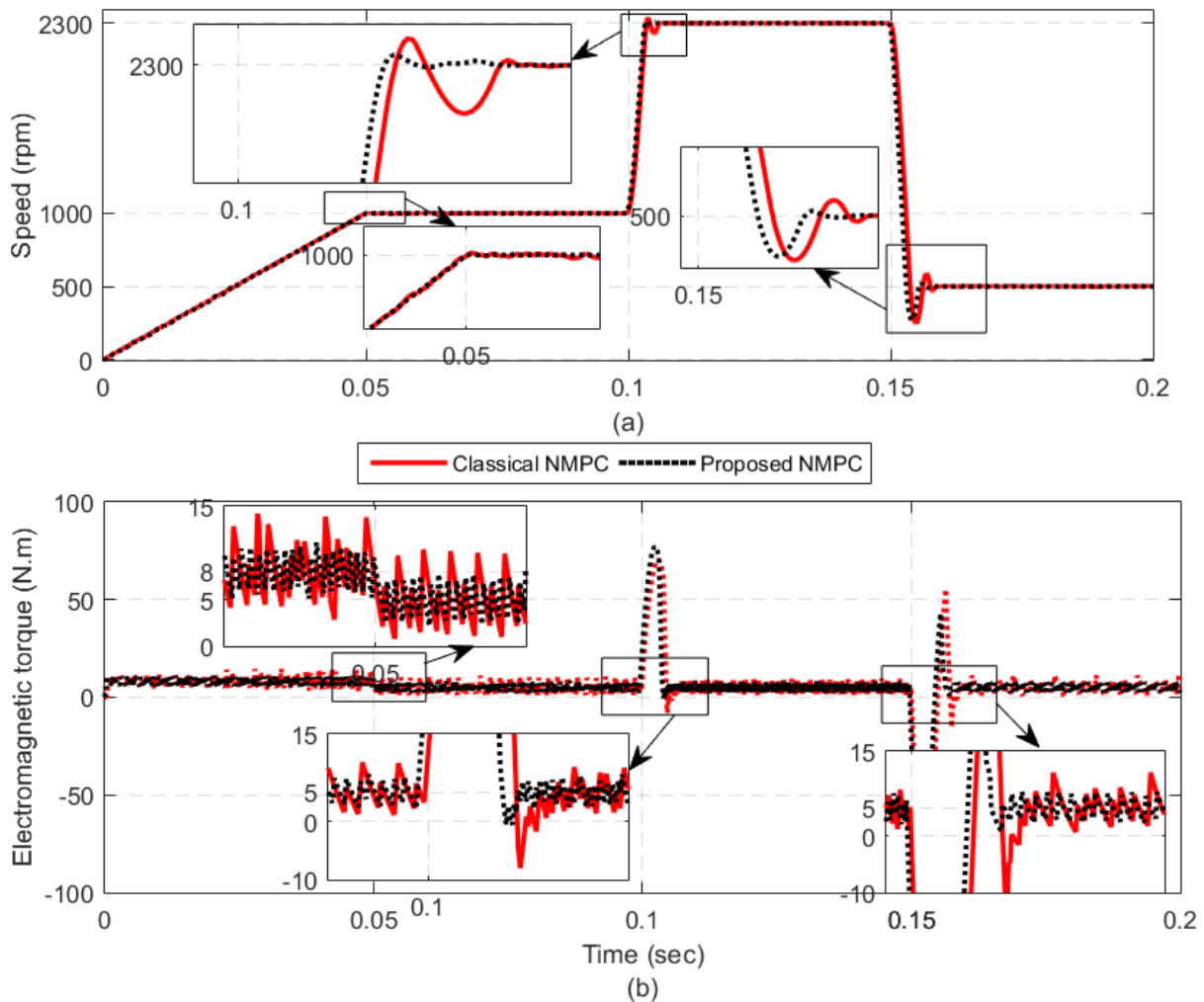

**Fig. 5** a) Speed tracking performance with constant load torque ( $T_L = 5$  Nm) and b) Electromagnetic torque response for speed reference steps.

**Table 3** Control specifications.

Drive System	Prediction Horizon ( $N_p$ )	Control Horizon ( $N_c$ )	Computational Time for [0-0.2sec] (s)
Classical NMPC	5	1	10.246
Classical NMPC + Proposed cost function	3	1	6.429
Classical NMPC + Proposed cost function + Incremental algorithm	3	1	5.817

control system to give a better tracking performance with a lower number of prediction horizon. As a result, the computational time is also reduced for 1.7 times. In order to show the effects of the proposed strategy in the Electromagnetic torque response shown in Fig. 5(b), the proposed NMPC provides the electromagnetic torque with lower ripple than the classical NMPC.

#### 4.2.2 Speed Tracking Performance When Load Torque Changes

In this section, the load torque increases from 0 to

10 Nm at  $t = 0.05$  s and then comes back to zero at  $t = 0.15$  s, while the motor is running at a constant speed. The results are presented for  $\omega = 1000$  rpm in Figs. 6(a) and 6(b) and for  $\omega = 2000$  rpm in Figs. 6(c) and 6 (d).

The PMSM should quickly provide the electromagnetic torque required for the load torque changes along with accurate tracking of the reference speed. Fig. 6(a) and 6(c), show the good speed tracking performance of the proposed method for a full-scale load torque change. Of course it should be noted that, the

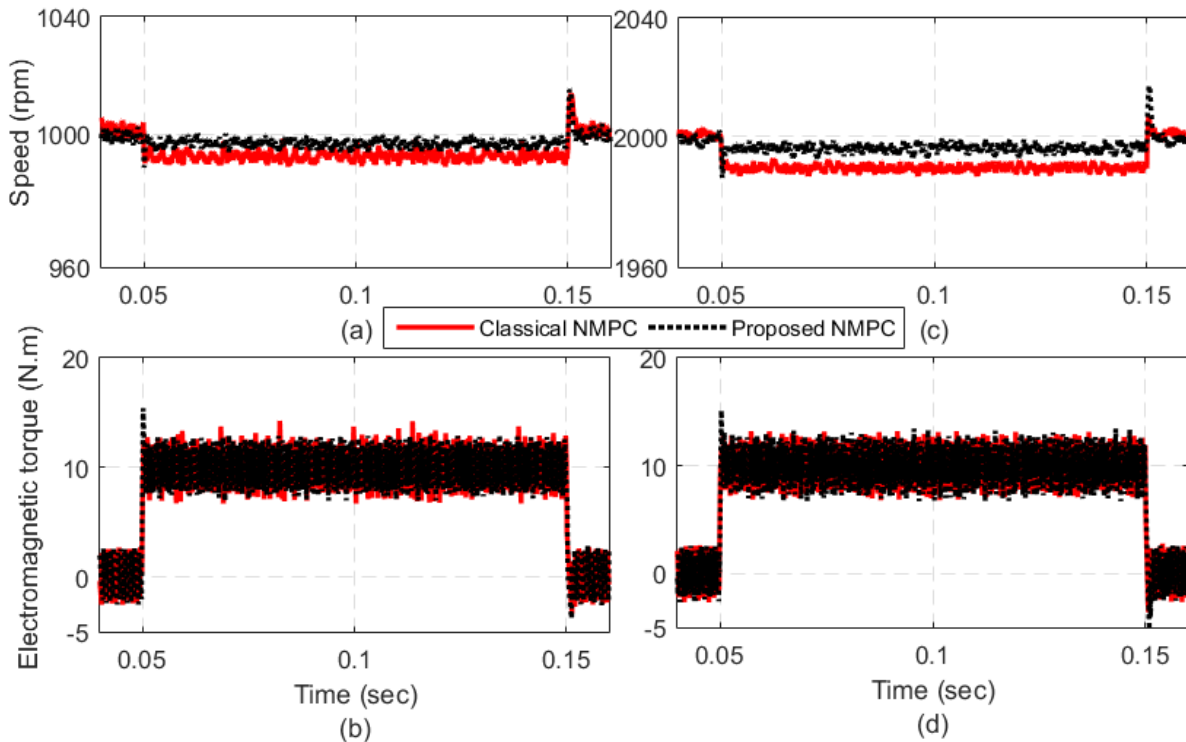

Fig. 6 Speed and electromagnetic torque responses for load torque steps in two various speed.

classical NMPC has also a good speed tracking with a slight error, which at steady-state and for a more time simulation it will be close to zero. Also as shown in Fig. 6(c) and 6(d), in both the cases, the proposed NMPC gives better results compared to classical MPC.

### 4.3 Sensitivity Analysis

For evaluation of robustness of the proposed method, the proposed controller is tested for three cases: parameters variations, noise in input and noise in output. Such variations are due to coils temperature rise, short circuits, measurements or estimation errors.

In the case of parameter variations, 50% increase in the stator and rotor resistance and 50% decrease in the stator and rotor inductance of the PMSM has occurred. For this purpose, in the simulations, the value of desired parameter is changed in the PMSM model but, it is kept constant in the predicted model. The effect of these variations on the speed tracking of the proposed controller is shown in Fig. 7. For the cases of parameters variations, the PMSM is rotating at 1000 rpm with no load. First, load torque changes to nominal value (0-10 Nm) at  $t = 0.05$  s, then at  $t = 0.1$  s, the speed reference changes to 2000 rpm and finally, the load torque returns to zero at  $t = 0.15$  sec. As shown in waveforms of Fig. 7, even though both methods have satisfactory responses, the proposed NMPC indicate the better speed tracking performance with lower overshoots, lower ripples and smaller errors when the stator and rotor resistance increases and stator and rotor inductance, respectively.

In the case of noise in input and output, 5% error has been added to all measurements and estimations in the controller. Similar to part A, in this case the reference speed accelerates up to 1000 rpm in 0.05 s, while the load torque is equal to the nominal value (10 Nm). Then, the reference speed is stepped from 1000 to 2300 rpm at  $t = 0.1$  s, and then comes back to 500 rpm at  $t = 0.15$  s. Fig. 8 shows the speed and electromagnetic responses of the controllers in the case of 5% noise in all the input signals and all the measurements and estimations.

As shown in Fig. 8, proposed and classical NMPC have satisfactory performance the proposed NMPC. However, the proposed NMPC tracks the speed reference with lower overshoots and error. Finally, it can be said that, the proposed NMPC with less number of prediction horizon has a better performance in different conditions compared to the classical NMPC.

### 5 Conclusion

In this paper, a new optimization strategy for MPC method is proposed. It utilizes a sequence of weighting factors to gradually reduce the effect of the following errors over the prediction horizon. The paper also suggests using an incremental algorithm to avoid examining all the inputs over the prediction horizon. Therefore, the use of proposed method reduces the computation burden of the control system. Hence, it can be employed for a wide range of nonlinear systems. The proposed NMPC is evaluated for an SPMSM drive system by simulation. The simulation results prove the

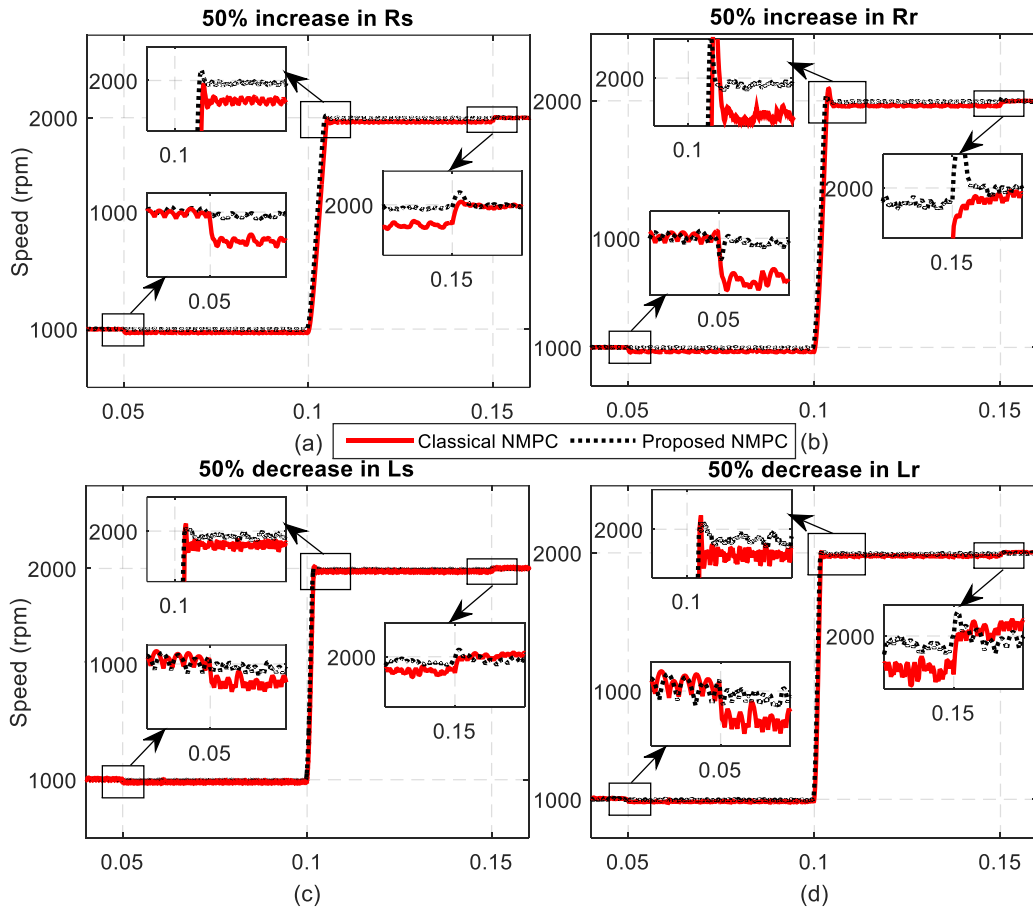

**Fig. 7** Speed responses for motor parameters variations, a) 50% increase in stator resistance, b) 50% increase in rotor resistance, c) 50% decrease in stator inductance and d) 50% decrease in rotor inductance.

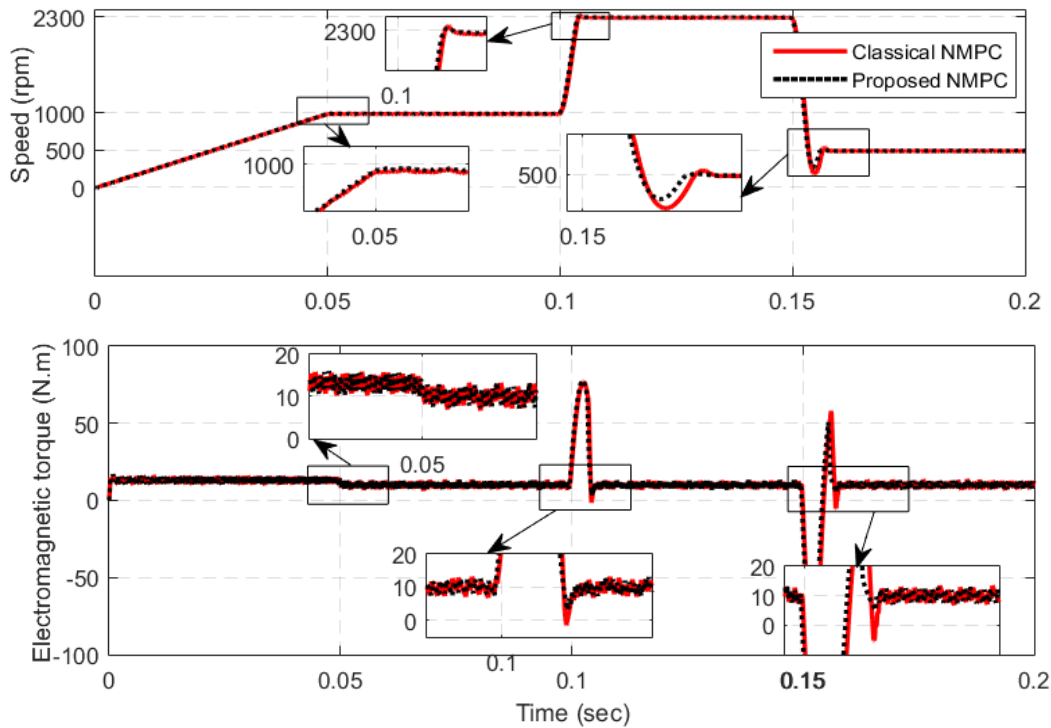

**Fig. 8** Speed and torque responses for noise in input and noise in output.



benefits of the proposed NMPC against the classical NMPC, which are listed as follows:

- It reduces the computational time up to 1.7 times;
- Faster dynamic response;
- Lower overshoots;
- More robust against parameter variations, noise in input and noise in output.

## References

- [1] S. Ahmadi and A. Vahedi, "Rotor Design of IPMSM Traction Motor Based on Multi- Objective Optimization using BFGS Method and Train Motion Equations," *Iranian Journal of Electrical and Electronic Engineering*, Vol. 11, No. 3, pp. 217–221, 2015.
- [2] A. Younesi and S. Tohidi, "Design of a sensorless controller for PMSM using Krill Herd algorithm," in *The 6th Power Electronics, Drive Systems & Technologies Conference (PEDSTC2015)*, pp. 418–423, 2015.
- [3] A. Younesi, Y. Kazemi, A. Moradpour and S. Tohidi, "Optimized sensor and sensorless control of PMSM modeled in discrete mode: A comparison of KH and PSO algorithms," *COMPEL - The international journal for computation and mathematics in electrical and electronic engineering*, Vol. 35, pp. 1293–1320, 2016.
- [4] H. Liu and S. Li, "Speed Control for PMSM Servo System Using Predictive Functional Control and Extended State Observer," *IEEE Transactions on Industrial Electronics*, Vol. 59, pp. 1171–1183, 2012.
- [5] I. Takahashi and T. Noguchi, "A New Quick-Response and High-Efficiency Control Strategy of an Induction Motor," *IEEE Transactions on Industry Applications*, Vol. IA-22, pp. 820–827, 1986.
- [6] M. Farasat, A. M. Trzynadlowski and M. S. Fadali, "Efficiency improved sensorless control scheme for electric vehicle induction motors," *IET Electrical Systems in Transportation*, Vol. 4, pp. 122–131, 2014.
- [7] K. B. Lee and F. Blaabjerg, "Sensorless DTC-SVM for Induction Motor Driven by a Matrix Converter Using a Parameter Estimation Strategy," *IEEE Transactions on Industrial Electronics*, Vol. 55, pp. 512–521, 2008.
- [8] G. S. Buja and M. P. Kazmierkowski, "Direct torque control of PWM inverter-fed AC motors - a survey," *IEEE Transactions on Industrial Electronics*, Vol. 51, pp. 744–757, 2004.
- [9] C. Kuang-Yao and T. Ying-Yu, "Fuzzy optimization techniques applied to the design of a digital PMSM servo drive," *IEEE Transactions on Power Electronics*, Vol. 19, pp. 1085–1099, 2004.
- [10] N. Golea, A. Golea and M. Kadjoudj, "Robust MRAC Adaptive Control of PMSM drive under General Parameters Uncertainties," in *2006 IEEE International Conference on Industrial Technology*, pp. 1533–1537, 2006.
- [11] J. R. Domínguez, A. Navarrete, M. A. Meza, A. G. Loukianov and J. Cañedo, "Digital Sliding-Mode Sensorless Control for Surface-Mounted PMSM," *IEEE Transactions on Industrial Informatics*, Vol. 10, pp. 137–151, 2014.
- [12] K. Jezernik, J. Korelič and R. Horvat, "PMSM sliding mode FPGA-based control for torque ripple reduction," *IEEE Transactions on Power Electronics*, Vol. 28, pp. 3549–3556, 2013.
- [13] Y. Jiang, W. Xu and C. Mu, "Robust Sliding Mode Speed Control with Adaptive Torque Observer for High Performance PMSM," in *2016 IEEE Vehicle Power and Propulsion Conference (VPPC)*, 2016, pp. 1–6.
- [14] H. Chaoui and P. Sicard, "Adaptive Fuzzy Logic Control of Permanent Magnet Synchronous Machines with Nonlinear Friction," *IEEE Transactions on Industrial Electronics*, Vol. 59, pp. 1123–1133, 2012.
- [15] J. Yang, W. H. Chen, S. Li, L. Guo and Y. Yan, "Disturbance/Uncertainty Estimation and Attenuation Techniques in PMSM Drives – A Survey," *IEEE Transactions on Industrial Electronics*, Vol. 64, No. 4, pp. 3273–3285, 2017.
- [16] D. Casadei, G. Serra and A. Tani, "Implementation of a direct control algorithm for induction motors based on discrete space vector modulation," *IEEE Trans, Power Electron.*, Vol. 15, No. 4, pp. 769–777, 2000.
- [17] X. Wei, D. Chen and C. Zhao, "Minimization of torque ripple of direct torque controlled induction machines by improved discrete space vector modulation," *Electric Power Systems Research*, Vol. 72, No. 2, pp. 103–112, 2004.
- [18] S. Vazquez, J. I. Leon, L. G. Franquelo, J. Rodríguez, H. A. Young, A. Marquez and P. Zanchetta, "Model Predictive Control: A Review of Its Applications in Power Electronics," *IEEE Industrial Electronics Magazine*, Vol. 8, No. 1, pp. 16–31, 2014.

- [19] M. Rivera, P. Wheeler, A. Olloqui and D. A. Khaburi, "A review of predictive control techniques for matrix converters; Part II," in *2016 7th Power Electronics and Drive Systems Technologies Conference (PEDSTC)*, pp. 589–595, 2016.
- [20] C. Bordons and C. Montero, "Basic Principles of MPC for Power Converters: Bridging the Gap between Theory and Practice," *IEEE Industrial Electronics Magazine*, Vol. 9, No. 3, pp. 31–43, 2015.
- [21] S. Chai, L. Wang and E. Rogers, "A Cascade MPC Control Structure for a PMSM With Speed Ripple Minimization," *IEEE Transactions on Industrial Electronics*, Vol. 60, No. 8, pp. 2978–2987, 2013.
- [22] J. Z. Lu, "Closing the gap between planning and control: A multiscale MPC cascade approach," *Annual Reviews in Control*, Vol. 40, pp. 3–13, 2015.
- [23] M. Preindl and S. Bolognani, "Model Predictive Direct Torque Control With Finite Control Set for PMSM Drive Systems, Part 1: Maximum Torque Per Ampere Operation," *IEEE Transactions on Industrial Informatics*, Vol. 9, No. 4, pp. 1912–1921, 2013.
- [24] M. Preindl and S. Bolognani, "Model Predictive Direct Torque Control With Finite Control Set for PMSM Drive Systems, Part 2: Field Weakening Operation," *IEEE Transactions on Industrial Informatics*, Vol. 9, No. 2, pp. 648–657, 2013.
- [25] C. S. Lim, N. A. Rahim, W. P. Hew and E. Levi, "Model Predictive Control of a Two-Motor Drive With Five-Leg-Inverter Supply," *IEEE Transactions on Industrial Electronics*, Vol. 60, No. 1, pp. 54–65, 2013.
- [26] A. Hamidi, A. Ahmadi and S. Karimi, "Implementation of Low-Cost Architecture for Control an Active Front End Rectifier," *Iranian Journal of Electrical and Electronic Engineering*, Vol. 14, No. 1, pp. 1–10, Mar. 2018.
- [27] M. Preindl and S. Bolognani, "Model Predictive Direct Speed Control with Finite Control Set of PMSM Drive Systems," *IEEE Transactions on Power Electronics*, Vol. 28, No. 2, pp. 1007–1015, 2013.
- [28] R. Kennel and A. Linder, "Generalized predictive control (GPC) Ready for use in drive applications" in *IEEE 32<sup>nd</sup> Annual Power Electronics Specialists Conference*, Vol. 4, pp. 1839–1844, 2002.
- [29] P. Cortés, M. P. Kazmierkowski, R. M. Kennel, D. E. Quevedo and J. Rodríguez, "Predictive Control in Power Electronics and Drives," *IEEE Transactions on Industrial Electronics*, Vol. 55, No. 12, pp. 4312–4324, 2008.
- [30] J. Thomas and A. Hansson, "Speed Tracking of a Linear Induction Motor-Enumerative Nonlinear Model Predictive Control," *IEEE Transactions on Control Systems Technology*, Vol. 21, No. 5, pp. 1956–1962, 2013.
- [31] M. Siami, D. A. Khaburi, M. Rivera and J. Rodríguez, "A Computationally Efficient Lookup Table Based FCS-MPC for PMSM Drives Fed by Matrix Converters," *IEEE Transactions on Industrial Electronics*, Vol. 64, No. 10, pp. 7645–7654, Oct. 2017.
- [32] M. Siami, D. Arab Khaburi and J. Rodríguez, "Simplified Finite Control Set-Model Predictive Control for Matrix Converter-Fed PMSM Drives," in *IEEE Transactions on Power Electronics*, Vol. 33, No. 3, pp. 2438–2446, March 2018.
- [33] Z. Zhou, C. Xia, Y. Yan, Z. Wang and T. Shi, "Disturbances Attenuation of Permanent Magnet Synchronous Motor Drives Using Cascaded Predictive-Integral-Resonant Controllers," *IEEE Transactions on Power Electronics*, Vol. 33, No. 2, pp. 1514–1527, Feb. 2018.
- [34] W. Wang, J. Zhang and M. Cheng, "Common Model Predictive Control for Permanent-Magnet Synchronous Machine Drives Considering Single-Phase Open-Circuit Fault," *IEEE Transactions on Power Electronics*, Vol. 32, No. 7, pp. 5862–5872, Jul. 2017.
- [35] Z. Mynar, L. Vesely and P. Vaclavek, "PMSM Model Predictive Control With Field-Weakening Implementation," *IEEE Transactions on Industrial Electronics*, Vol. 63, No. 8, pp. 5156–5166, Aug. 2016.
- [36] W. C. Wang, T. H. Liu and Y. Syaifudin, "Model Predictive Controller for a Micro-PMSM-Based Five-Finger Control System," *IEEE Transactions on Industrial Electronics*, Vol. 63, No. 6, pp. 3666–3676, Jun. 2016.
- [37] P. Kakosimos and H. Abu-Rub, "Predictive Speed Control With Short Prediction Horizon for Permanent Magnet Synchronous Motor Drives," *IEEE Transactions on Power Electronics*, Vol. 33, No. 3, pp. 2740–2750, Mar. 2018.
- [38] A. Younesi, S. Tohidi, M. R. Feyzi and M. Baradarannia, "An improved nonlinear model predictive direct speed control of permanent magnet synchronous motors," *International Transactions on Electrical Energy Systems*, Vol. 28, No. 5, p. e2535, 2018.



**A. Younesi** received the B.Sc. degree in Electrical Engineering from the University of Mohaghegh Ardabili, Ardabil, Iran, in 2013, and the M.Sc. degree in Electrical Engineering from the University of Tabriz, Tabriz, Iran, in 2015. He is currently pursuing the Ph.D. degree with the Department of Electrical and Computer Engineering, University of Tabriz, Tabriz, Iran. His research interests include electrical machine and drives, model predictive control, control of wind turbine generators.



**M. R. Feyzi** received his B.Sc. and M.Sc. in 1975 from the University of Tabriz in Iran with honor degree. He worked in the same university during 1975 to 1993. He started his Ph.D. work at the University of Adelaide, Australia in 1993. Soon after his graduation, he rejoined to the University of Tabriz. Currently, he is a Professor in the same university. His research interests are finite element analysis, design and simulation of electrical machines and transformers.



**S. Tohidi** was born in Meshkin Shahr, Iran, in 1984. He received the B.Sc. degree from Iran University of Science and Technology (IUST), Tehran, Iran, in 2006, and M.Sc. degree from Sharif University of Technology, Tehran, Iran, in 2008, both in Electrical Engineering.

He is currently an Assistant Professor at University of Tabriz, Iran. He was on sabbatical at Durham University, Durham, U.K., and University of Cambridge, Cambridge, U.K., in 2011. His research interests include power systems dynamics, electrical machines, and wind power generation.



© 2018 by the authors. Licensee IUST, Tehran, Iran. This article is an open access article distributed under the terms and conditions of the Creative Commons Attribution-NonCommercial 4.0 International (CC BY-NC 4.0) license (<https://creativecommons.org/licenses/by-nc/4.0/>).