

Performance Improvement of Direct Torque Controlled Interior Permanent Magnet Synchronous Motor Drives Using Artificial Intelligence

K. Malekian*, J. Milimonfared** and B. Majidi**

Abstract: The main theme of this paper is to present novel controller, which is a genetic based fuzzy Logic controller, for interior permanent magnet synchronous motor drives with direct torque control. A radial basis function network has been used for online tuning of the genetic based fuzzy logic controller. Initially different operating conditions are obtained based on motor dynamics incorporating uncertainties. At each operating condition, a genetic algorithm is used to optimize fuzzy logic parameters in closed-loop direct torque control scheme. In other words, the genetic algorithm finds optimum input and output scaling factors and optimum number of membership functions. This optimization procedure is utilized to obtain the minimum speed deviation, minimum settling time, zero steady-state error. The control scheme has been verified by simulation tests with a prototype interior permanent magnet synchronous motor.

Keywords: Direct Torque Control, Field Weakening, Interior Permanent Magnet Synchronous Motor, Maximum Torque per Ampere.

1 Introduction

Since Depenbrock [1] and Takahashi [2] proposed direct torque control (DTC) for induction motor drives in the middle of 1980s, more than two decades has passed. The basic principle of DTC is to directly select stator voltage vectors according to the differences between the references of torque and stator flux linkage and their actual values. Many papers on the control of torque of permanent magnet synchronous motors in the constant torque (maximum torque per ampere) region and the field-weakening region have appeared in recent years [3]-[5].

The high-performance speed tracking for direct torque controlled Permanent Magnet Synchronous Motor (PMSM) drives can be achieved by designing an appropriate speed controller. Traditionally, the control issues are handled by conventional proportional-integral (PI), proportional-integral-derivative (PID) controllers and various adaptive controllers such as model reference adaptive controller, sliding-mode

controller [6], variable-structure controller [7], etc. However, the difficulties of obtaining the exact d-q axes reactance parameters of the Interior Permanent Magnet Synchronous Motor (IPMSM) leads to cumbersome design approach for these controllers. Furthermore, the conventional fixed-gain PI and PID controllers are very sensitive to step change of command speed, parameter variations, and load disturbance [8]. Again, precise speed control of an IPMSM drive becomes a complex issue due to nonlinear coupling among its winding currents and the rotor speed as well as the nonlinearity present in the electromagnetic developed torque due to magnetic saturation of the rotor core [9]. Because of these nonlinear natures of the IPMSM, an intelligent controller demands special attention for precise speed control of high-performance drive systems.

The use of Artificial Neural Network (ANN) alone to design a controller for IPMSM drive might be insufficient, if the test inputs used to generate training input/output pairs are not rich enough to excite all modes of the system. On the other hand, Fuzzy Logic Controllers (FLCs) are subjective and somewhat heuristic. In previous cases, the determination of fuzzy rules, input and output scaling factors, and the choice of membership functions depend on trial-and-error that makes the design of FLC a time-consuming task [10]. To overcome this problem, a Genetic based Fuzzy

Iranian Journal of Electrical & Electronic Engineering, 2009.

Paper first received 11 Dec. 2007 and in revised form 29 Sep. 2008.

* Kaveh Malekian is with the Department of Electrical and computer Engineering, Chemnitz University of Technology, 09126 Chemnitz, Germany.

E-mail: kaveh.malekian-boroujeni@etit.tu-chemnitz.de

** The authors are with the Department of Electrical Engineering, Amirkabir University of Technology, Teheran, Iran.

E-mail: monfared@aut.ac.ir

Logic Controller (GFLC) is developed in the present work.

Initially different operating conditions are obtained based on motor dynamics incorporating uncertainties. At each operating condition a genetic algorithm is used to optimize fuzzy logic parameters in closed-loop direct torque control scheme. In other words, the genetic algorithm finds optimal input and output scaling factors and optimum number of membership functions. This optimization procedure is utilized to obtain the minimum speed deviation, minimum settling time, zero steady-state error. A Radial Basis Function Network (RBFN) is used for online tuning of the fuzzy logic controller parameters (input and output scaling factors and number of membership functions) to ensure optimum drive performance under different disturbances.

2 Motor Dynamics

In the rotor reference frame, the voltage equation and the torque equation of IPM motors are expressed as follows:

$$\begin{pmatrix} V_q \\ V_d \end{pmatrix} = \begin{pmatrix} R + pL_q & \omega L_d \\ -\omega L_q & R + pL_d \end{pmatrix} \begin{pmatrix} i_q \\ i_d \end{pmatrix} + \begin{pmatrix} \omega \psi_f \\ 0 \end{pmatrix} \quad (1)$$

$$T_e = \frac{3P\psi_s}{4L_d L_q} [2\psi_f L_q \sin\delta - \psi_s (L_q - L_d) \sin 2\delta] \quad (2)$$

where,

- i_q, i_d q- and d-axis components of armature current;
- V_q, V_d q- and d-axis components of terminal voltage;
- T_e electromagnetic torque;
- ψ_f rotor magnetic flux linking the stator;
- ψ_s stator flux linkage;
- R armature resistance;
- L_q, L_d q- and d-axis components of stator inductances;
- P = d/dt;
- P number of pole pairs;
- ω electrical speed ($=P\omega_m$); and
- Δ load angle.

According to [4], stable torque control can be achieved if (3) and (4) are satisfied

$$\psi_s < \frac{L_q}{L_q - L_d} \psi_f \quad (3)$$

$$\delta < \cos^{-1} \left(\frac{1}{4} \left(\frac{a}{\psi_s} - \sqrt{\left(\frac{a}{\psi_s} \right)^2 + 8} \right) \right) \quad (4)$$

where $a = (L_q / (L_q - L_d)) \psi_f$.

3 Control Strategies for Direct Torque Control

The high-performance speed tracking can be achieved using maximum torque per ampere (MTPA) strategy in constant torque region (below the base speed) and flux-weakening (FW) strategy in constant power region (above the base speed).

The basic idea of DTC for induction motor which is to control the flux linkage and torque by selecting the voltage space vectors properly is now being adopted by the industry.

The optimum drive performance can be achieved by determining proper values of electromagnetic torque and stator flux linkage commands. In order to consider the machine constraints (the current and voltage constraints) and to implement the MTPA and the FW strategies in the direct torque control, these constraints and strategies must be expressed in the T_e - ψ_s plane. To achieve this purpose, (5) can be used for mapping the constraints and strategies from i_q - i_d plane into T_e - ψ_s plane.

$$\begin{cases} T_e = \frac{3P}{2} [\psi_f i_q - (L_q - L_d) i_d i_q] \\ \psi_s = \sqrt{(L_d i_d + \psi_f)^2 + (L_q i_q)^2} \end{cases} \quad (5)$$

The constraints and control trajectories, so calculated for the motor in Table 1 for positive torque, are indicated on the T_e - ψ_s plane in Fig. 1.

The electromagnetic torque command T_e^* is decided from the speed error ($\omega^* - \omega$) through the GFLC (asterisks designate commanded values throughout this paper). The stator flux linkage command ψ_s^* is decided by the MTPA strategy below the base speed and by the FW strategy above the base speed according to T_e^* and ω ($=P\omega_m$). Below the base speed ω_{base} , the MTPA control is selected because the voltage constraint is always satisfied. Above the base speed ω_{base} , the control mode is determined by checking the voltage constraint satisfaction. If voltage constraint is satisfied, then the MTPA control is selected, or else the FW control is selected.

4 Proposed New Technique

The specific objective of this paper is to obtain the IPMSM control voltages in order to achieve high-performance speed tracking. The block diagram of the closed-loop direct torque control scheme of the IPMSM incorporating the proposed new controller is shown in Fig. 2. The electromagnetic torque command T_e^* is determined from the speed error ($\omega^* - \omega$) using the genetic based fuzzy logic controller (GFLC) as shown in Fig. 2. The stator flux linkage command ψ_s^* is determined by the method that has been described in previous section. As shown in Fig. 3, the GFLC, which is applied in order to achieve high-performance speed

tracking, contains an FLC, which is on-line tuned using a trained RBFN. In other words, a trained RBFN is utilized for on-line tuning the FLC parameters (the input and output scaling factors and number of membership functions) at each operating condition. The initial data for training the RBFN, at each operating condition, is extracted using GA.

In the following subsections, the FLC, the GA used for optimizing of the FLC parameters, and the RBFN used for on-line tuning of the FLC parameters are explained.

4.1 FLC Scheme

The FLC, which is used to achieve speed tracking, has two inputs and one output. Its inputs are speed error ($\omega^* - \omega$) and derivative of speed error $d(\omega^* - \omega)/dt$ and its output is the electromagnetic torque, T_e^* . To satisfy the current and voltage constraints, it is necessary that the FLC output be modified. Initially, five membership functions are selected for both inputs. This number may be varied by the GA for the optimization of FLC. Also, five membership functions are selected for output T_e^* . Input and output membership functions are shown in Fig. 4. The initial fuzzy control rule-bases are given in Table 2 and the corresponding control surface of the normalized FLC is shown in Fig. 5.

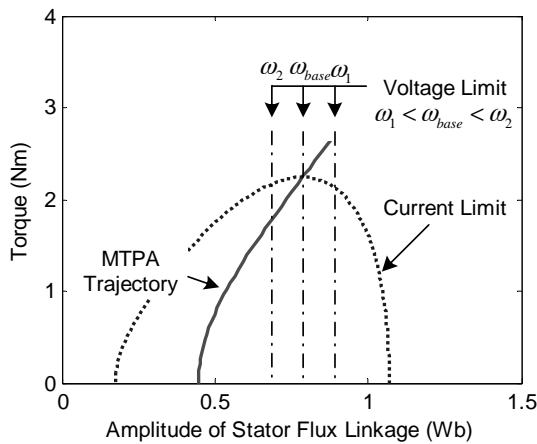

Fig. 1. Constraints and control trajectories in T_e - ψ_s plane.

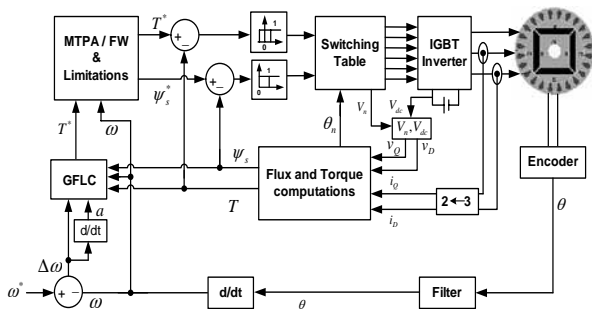

Fig. 2. Block diagram of the proposed GFLC-based IPMSM drive

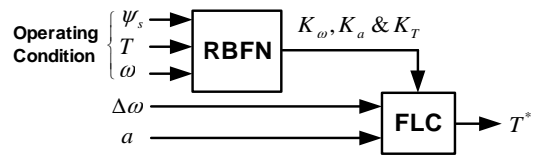

Fig. 3. Block diagram of the proposed GFLC.

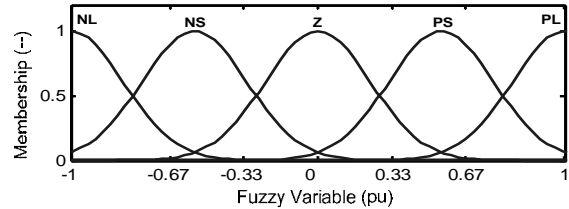

Fig. 4. The initial membership functions of fuzzy variables (speed error, derivative of speed error, and the torque command).

Table 1 Data of IPMSM used in simulation.

Maximum current	I_{am}	8.66 A
Maximum voltage	V_{am}	50 V
Base speed	ω_{base}	1200 rpm
Number of pole pairs	P_n	2
d-axis inductance	L_d	8.72 mH
q-axis inductance	L_q	22.8 mH
Stator resistance	R	0.57 Ω
Magnetic flux-linkage	ψ_f	0.311 v/rad/s
Motor inertia	J_m	0.003 kgm ²
Friction coefficient	B_m	0.001 Nm/rad/s

Table 2 Initial fuzzy control rule-base.

$\Delta\omega$ \ a	NL	NS	Z	PS	PL
NL	NL	NL	NL	NS	NS
NS	NL	NS	NS	NS	Z
Z	NS	Z	Z	Z	NS
PS	Z	PS	PS	PS	PL
PL	PS	PS	PL	PL	PL

4.2 GA

GAs are exploratory search and optimization procedures that were devised on the principles of natural evolution and population genetics [11]. In this paper GA is used to optimize the FLC parameters. First, various operating conditions are generated randomly by taking into account different drive uncertainties based on (1) and (2). At each operating condition, optimal input and output scaling factors and optimum number of membership functions are obtained using GA. Each chromosome consists of five genes that are input and output scaling factors (K_ω , K_a , and K_T) and number of membership functions (N_ω and N_a).

Two-point-random method is used for crossover. In order to simultaneously achieve zero steady-state error, minimum speed deviation and minimum settling time of the IPMSM drive, the following fitness function is selected which can cover all the above purposes.

$$\text{fitness} = \int_0^t (\omega^* - \omega)^2 t \cdot dt \quad (6)$$

Using GA for several operating conditions the optimum values of the FLC parameters have been found. For the sake of simplification, number of membership functions (N_ω and N_a) are tuned off-line. Thus, they should be same in any operating condition. So if any operating conditions they are different from optimal value, the GA should be run again. In this work, the optimal values of parameters N_ω and N_a for the proposed GFLC are found as follows: $N_\omega=5$, $N_a=3$. Consequently, the number of the FLC rules is reduced from 25 to 15. The optimized fuzzy control rule-bases are given in Table 3.

If N_ω and N_a are different from 5 and 3 at any operating condition, the GA must be repeated for them. Unlike N_ω and N_a , which are tuned off-line, the optimum K_ω , K_a , and K_T are saved in a look-up table and are tuned on-line via an RBFN.

4.3 RBFN

Like most feed forward networks, RBFN has three layers, namely, an input layer, a hidden layer, and an output layer [12]. A schematic diagram of the specific RBFN with 2 inputs and 3 outputs is given in Fig. 6.

Using the results in previous section, an RBFN which can map the output variables with a nonlinear relationship has been trained. The input variables of RBFN are the rotor speed, electromagnetic torque, and stator flux linkage. The outputs of RBFN are the optimum input and output scaling factors (K_ω , K_a , and K_T). The trained RBFN is used for on-line tuning of optimum K_ω , K_a , and K_T .

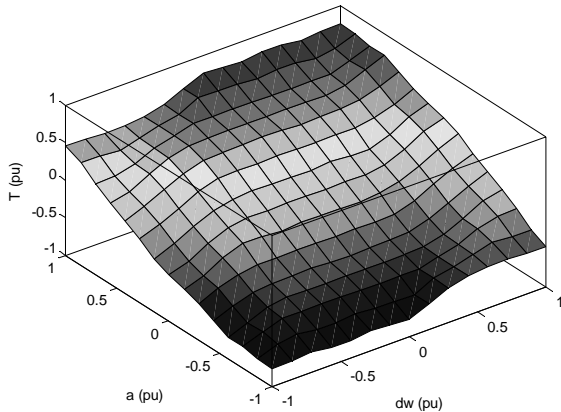

Fig. 5. Control surface of the normalized FLC.

Table 3 Optimized fuzzy control rule-base.

$\Delta\omega$	NL	NS	Z	PS	PL
a	NL	NS	Z	PS	PL
NS	NL	NS	NS	NS	Z
Z	NS	Z	Z	Z	NS
PS	Z	PS	PS	PS	PL

5 Simulation

Several tests are performed to evaluate the performance of the proposed IPMSM drive system in simulation. The speed and torque responses are observed under different operating conditions such as sudden change in command speed, step change in load, etc. Sample results are presented below. The complete drive has been simulated using MATLAB/Simulink for the prototype IPMSM of Table 1.

The speed control loop of the drive is also designed and simulated with a PI controller, in order to compare the performance to those obtained from the respective proposed drive systems. In order to make a fair comparison the PI controller is tuned at rated conditions.

The simulated responses of the drive are shown in Fig. 7(a)-(b) for the drive with PI controller and the proposed drive system, respectively. From these figures, one can observe the starting performance as well as the response with a load disturbance. The drive system is started at no load condition with the speed reference set at 1200 rpm (125.6 rad/s). It is seen from Fig. 7(a) that the proposed drive can follow the command speed within 0.05 s without any over-shoot, undershoot, and steady-state error, whereas that the PI controller suffers from a big overshoot and takes a long time to reach the steady state. At $t=1s$, a load torque of 2 N.m is applied to the motor shaft in a stepwise manner. Also, in this case the GFLC-based drive system shows the superiority over PI as the actual speed does not change during the load disturbance.

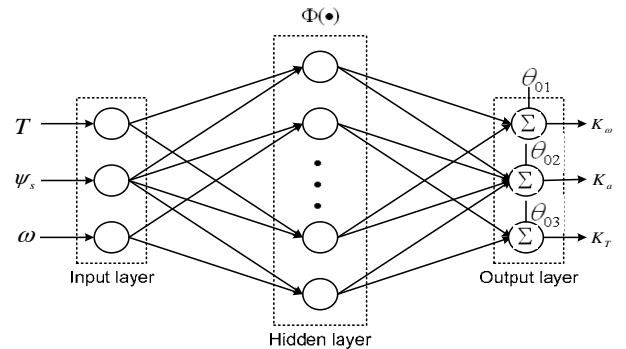

Fig. 6. Schematic diagram of RBFN.

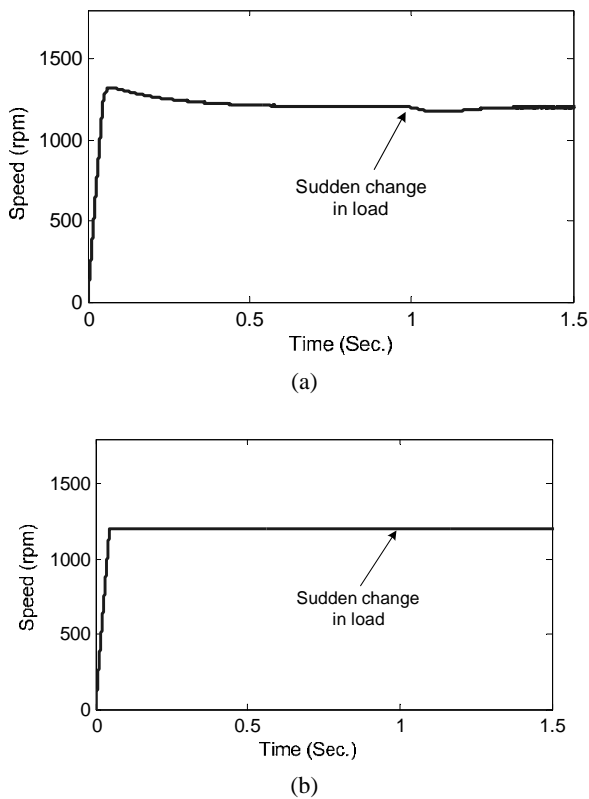

Fig. 7. Simulated speed response of the both drive with the PI controller (a) and the proposed drive system (b).

Fig. 8(a)-(c) shows another dynamic response of speed and torque of the proposed drive system with respect to a step change in speed reference from 500 to 2000 rpm. As mentioned in Table 1, the base speed of the prototype IPMSM is 1200 rpm. Below the base speed, the applied strategy is MTPA, whereas above the base speed, FW strategy must be utilized. It is seen from these figures that transitions between the constant torque and FW operations are very smooth. Firstly, the motor is driven at no load condition. At $t=0.3s$, a step load torque of 1 N.m is applied to the motor shaft. Like in constant region, the speed response is indifferent with respect to step change in applied torque in FW region.

Fig. 9(a)-(c) shows the transient values of scaling factors of the optimized FLC during the test. As shown in this figure, scaling factors are on-line tuned in a nonlinear manner with respect to changes of operating conditions such as step change in speed reference or step change in load torque. In other words, these scaling factors have own optimal values at each operating point. This matter ensures the optimal performance of FLC.

The simulation results shown in Figs. 7 and 8 have clearly demonstrated the superiority of the proposed system over prior works [13]-[14]. As shown in these figures, the proposed system has a proper dynamic

response in both constant torque and field weakening regions.

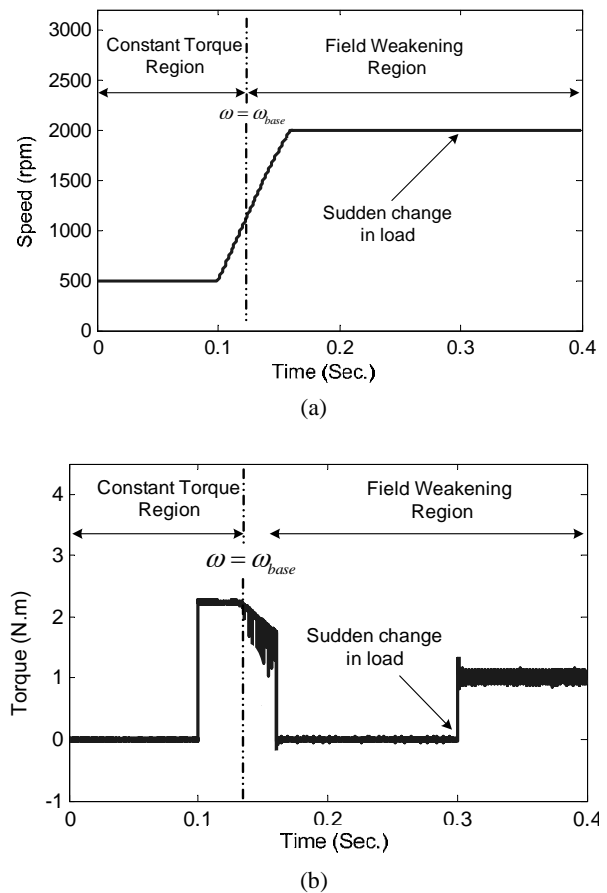

Fig. 8. Simulated dynamic responses of the proposed drive system in constant torque and FW regions.

5 Conclusions

The proposed GFLC-based direct torque control of an IPMSM drive over wide speed range has been investigated through analyses and simulation. In the proposed IPMSM drive system, an RBFN is used for online tuning of the parameters of optimized FLC. The FLC parameters have been optimized using a GA with a performance index to reflect the minimum settling time, minimum overshoot/undershoot, and zero steady-state error. Based on the optimized operating conditions and control parameters the RBFN has been developed and trained for online tuning of the FLC parameters. The validity of the proposed control technique has been established in simulation at different operating conditions such as sudden load change, step change of speed, etc. The drive has been found robust in terms of quick response and disturbance rejection. Moreover, Control regimes, such as the MTPA control and FW control with voltage and current constraints have been applied successfully.

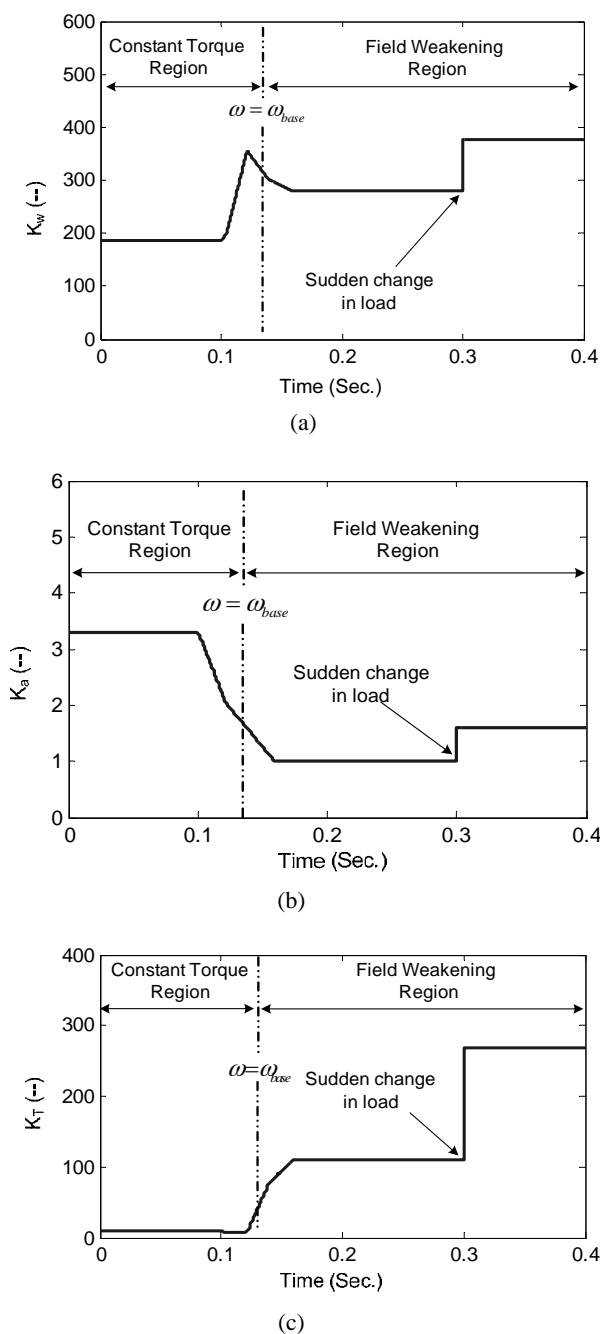

Fig. 9. The transient values of scaling factors in constant torque and FW regions.

References

[1] Depenbrock M., "Direct self-control of inverter-fed machine," *IEEE Trans. Power Electron.*, Vol. 3, pp. 420–429, Oct. 1988.

[2] Takahashi I. and Naguchi T., "A new quick-response and high-efficiency control strategy of an induction motor," *IEEE Trans. Ind. Applicat.*, Vol. IA-22, pp. 820–827, Sept./Oct. 1986.

[3] French C. and Acarnley P., "Direct torque control of permanent magnet drives," *IEEE Trans. Ind. Applicat.*, Vol. IA-32, pp. 1080–1088, Sept./Oct. 1996.

[4] Zhong L., Rahman M. F., Hu W. Y. and Lim K. W., "Analysis of direct torque control in permanent magnet synchronous motor drives," *IEEE Trans. Power Electron.*, Vol. 12, pp. 528–536, May 1997.

[5] Rahman M. F., Zhong L. and Lim K. W., "A direct torque controlled interior permanent magnet synchronous motor drive incorporating field weakening," *IEEE Trans. Ind. Applicat.*, Vol. 34, pp. 1246–1253, Nov./Dec. 1998.

[6] Lin F. J., Lin C. H. and Huang P. K., "Recurrent fuzzy neural network controller design using sliding-mode control for linear synchronous motor drive", *IEE Proc.-Control Theory Appl.*, Vol. 151, No. 4, pp. 407- 416, July 2004.

[7] Lin F. J., Lin C. H. and Shen P. H., "Variable-structure control for a linear synchronous motor using a recurrent fuzzy neural network", *IEE Proc.-Control Theory Appl.*, Vol. 151, No. 4, pp. 2108- 2113, July 2004.

[8] Uddin M. N., Radwan T. S. and Rahman M. A., "Performances of fuzzy logic based indirect vector control for induction motor drive," *IEEE Trans. Ind. Applicat.*, Vol. 38, pp. 1219–1225, Sept./Oct. 2002.

[9] Rahman M. A. and Zhou P., "Field circuit analysis of brushless permanent magnet synchronous motors," *IEEE Trans. Ind. Electron.*, Vol. 43, pp. 256–267, Apr. 1996.

[10] Uddin M. N. and Rahman M. A., "Fuzzy logic based speed control of an IPM synchronous motor drive," *J. Adv. Comput. Intell.*, Vol.4, No. 3, pp. 212–219, 2000.

[11] Goldberg D. E., "*Genetic Algorithms in Search, Optimization, and Machine Learning*", Reading, MA, Addison-Wesley, 1989.

[12] Ahido M. A. and Abdel-Magid Y. L., "Online identification of synchronous machines using radial basis function networks", *IEEE Trans. on Power Systems*, Vol. 12, No. 4, pp. 1500-1506, Nov. 1997.

[13] Ghasemi H. and Vaez-Zadeh S., "A very fast direct torque control for permanent magnet synchronous motors start up," *Canadian Conference on Electrical and Computer Engineering*, Vol. 3, pp. 1673- 1677, 2-5 May 2004.

[14] Mengjia J., Cenwei S., Jianqi Q. and Ruiguang L., "Stator flux estimation for direct torque controlled surface mounted permanent magnet synchronous motor drives over wide speed

region,” *The 8th International Conference on Electrical Machines and Systems*, Vol. 1, pp. 350-354, 27-29 Sep. 2005.



Kaveh Malekian was born in Borojen, Iran, on September 16, 1983. He received the B.Sc. degree in electrical engineering from Shahid Chamran University (Ahvaz Jondishapour Uni.) Ahvaz, Iran, in 2005 and the M.Sc. degree from the Amirkabir University of Technology (Tehran

Polytechnic Uni.), Tehran, Iran, in 2008. He has started his Ph.D. in Chemnitz University of Technology, Chemnitz, Germany, since 2008. His research interests include Power Electronics, Electric Motor Drives, Wind Energy, Intelligent Controls, as well as Design and Analysis of Electrical Machines.



Jafar Milimonfared was born in Tehran, Iran in 1953. He received the B.Sc. degree in electrical engineering from Amirkabir University of Technology (Tehran Polytechnic), Tehran, Iran in 1978 and the M.Sc. and Ph.D. degrees in electrical engineering from Paris VI

University, Paris, France in 1981 and 1984, respectively. Dr. Milimonfared joined the Amirkabir University of Technology as an assistant professor in 1984 where he is now a professor of electrical engineering. His research interests include electrical machines analysis and design, power electronics and variable speed drives. He is with Amirkabir University of Technology as a Professor of Electrical Engineering.



Behrooz Majidi is born in Isfahan, Iran. He received his M.Sc degree in electrical engineering from Amirkabir University of Technology (Tehran Polytechnic), Tehran, Iran. His research interests cover many aspects of power engineering including design and optimization of magnetic devices,

variable speed drives, and electric vehicles.