



A New Power Management Approach for PV-Wind-Fuel Cell Hybrid System in Hybrid AC-DC Microgrid Configuration

P. Bhat Nempu* and J. N. Sabhahit*(C.A.)

Abstract: The hybrid AC-DC microgrid (HMG) architecture has the merits of both DC and AC coupled structures. Microgrids are subject to intermittence when the renewable sources are used. In the HMG, since power fluctuations occur on both subgrids due to varying load and unpredictable power generation from renewable sources, proper voltage and frequency regulation is the critical issue. This article proposes a unique method for operating a microgrid (MG) comprising of PV array, wind energy system (WES), fuel cell (FC), and battery in HMG configuration. The control scheme of the interlinking converter (ILC) regulates frequency, voltage, and power flow amongst the subgrids. Power management in the HMG is investigated under different scenarios. Proper power management is accomplished within the individual subgrids and among the subgrids by the control techniques adopted in the HMG. The system voltage and frequency deviations are found to be minimized when the FC system acts as the backup source for DC subgrid, reducing the power flow through the ILC.

Keywords: PV Array, Fuel Cell, Wind Energy System, Hybrid AC-DC Microgrid, Battery, Interlinking Converter.

1 Introduction

RENEWABLE sources of energy are being employed for generating electricity recently since they are freely available and environmental friendly. Hybrid AC-DC MGs are advantageous as they avoid multiple power conversions. Voltage, power regulation in both AC and DC buses and power management between the subgrids are the major concerns in an HMG. Since HMGs experience power fluctuations in both the subgrids, a proper investigation of the control scheme for power management is necessary. In [1], the authors described the concept of hybrid AC-DC MGs and analyzed the HMG in both grid-tied and autonomous modes. The normalization based control scheme for the operation of the HMG is clearly presented in [2]. A study on both grid-integrated and

grid-independent operation of HMGs is presented. In [3], a detailed survey of different MG architectures is presented. The control schemes and requirements of different MG structures are reviewed. The advantages of HMG over DC and AC coupled MGs are described.

The control strategy for the autonomous HMGs is developed in [4]. A control technique that computes the power reference by minimizing the error among normalized frequency and DC bus voltage is described. A similar control technique is analyzed in detail and experimentally validated in [5]. The control scheme was improved by considering energy storage device and DC link capacitance control in [6]. A multi-stage energy management strategy for the HMG is proposed in [7].

A modified droop control scheme for the independent operation of HMGs with two levels is proposed in [8]. The frequency and voltage controller for autonomous HMG with battery is proposed in [9]. The same system is analyzed both in stand-alone and grid-tied modes with pulsed loads and experimental validation is made in [10]. A different PI-PO maximum power point tracking (MPPT) controller is developed for an independent hybrid MG involving PV, WES, and FC. This technique is found to be effective compared to traditional PO (perturb & observe) MPPT [11].

Iranian Journal of Electrical and Electronic Engineering, 2020.

Paper first received 28 January 2020, revised 18 March 2020, and accepted 10 April 2020.

* The authors are with the Department of Electrical and Electronics Engineering, Manipal Institute of Technology, Manipal Academy of Higher Education, Manipal, India.

E-mails: pramodbhatn@gmail.com and jayalakshmi.ns@manipal.edu.

Corresponding Author: J. N. Sabhahit.

An organized survey of different aspects of HMGs is presented in [12]. A predictive model based MG comprising of a hybrid of PV array and WES with battery is described in [13]. A two-level controller for the parallel operation of grid-connected HMGs is proposed in [14]. Simulation and experimental analysis are presented under unbalanced conditions of the grid voltage.

In [15], a control technique is developed to ensure an effective transition between grid-tied and the autonomous mode for an HMG. The security risk assessment of the HMG is presented in [16]. The voltage-power control scheme for the transition between different operating modes in an HMG is detailed in [17]. The application of high-frequency DC transformer for HMGs is described in [18]. Efficient operation is observed when the system is experimentally verified. The passivity based control algorithm for the stable operation of the HMG employing PV and WES is proposed in [19]. The quality of power and accuracy of power-sharing among the subgrids are enhanced.

The up-down operation model for the HMG is proposed in [20]. The effectiveness of that method is verified concerning voltage regulation during transient variations. Fuzzy logic-based control of battery system in an HMG involving PV array and battery on DC subgrid and the diesel generator, WES, and battery on the AC subgrid is described in [21]. A robust control scheme for power management of an HMG with the PV system, WES, diesel generator, and the battery is proposed in [22]. The diesel generator causes harmful emissions and hence it can be avoided in an MG.

In [23], a decentralized control scheme for the energy management of an HMG with PV array, WES, and FC is proposed and its effectiveness is evaluated for nonlinear and unbalanced loads. The adaptive droop control method for power-sharing among FC and battery systems in an MG is described in [24]. The advantages of the HMG over other MG configurations are clearly listed in [25].

In the literature, different control schemes are proposed for autonomous HMG. The coordinated control of sources and storage devices as per load demand on both subgrids, voltage, and frequency regulation are the key issues in an autonomous HMG. In [11, 13, 24], even though better control techniques are proposed, the system is not investigated with renewable sources on both AC and DC subgrids. In [21, 22], HMG architecture is considered. But due to the incorporation of diesel generator, the system is not environmental-friendly. In [23], the authors have considered the same energy sources used in this work. However, there is a need to highlight more on coordinated power management. There is very less emphasis in the literature on analyzing the operation of the HMG with a major focus towards the coordinated energy management of multiple alternative sources within the subgrids and between the subgrids.

Therefore, this paper explores the PV array, WES and FC based HMG in a distinctive configuration with a clear analysis of power management and associated aspects.

The significance of this research work is listed below.

- This article explores a new approach to operate a PV-wind-fuel cell hybrid system with battery in HMG structure. The result analysis highlights more on the power-sharing in the HMG and the impact of sudden changes in generation and demand.
- An extensive study of the proposed HMG is carried out and the role of the backup source (FC) while operating in the proposed method is signified. The FC system used in the DC subgrid helps to balance the demand and power generation in the DC bus. The slow dynamics of the FC system is compensated by power exchange from AC subgrid with the help of the battery. This is referred to as instantaneous power management. The operation of the system in the proposed configuration is evaluated under different scenarios based on voltage and frequency regulation and power management.

2 Structure of the Proposed HMG and Control Strategies

2.1 System Configuration

In this work, a PV system capable of delivering power of 15.75 kW at standard test condition is the primary source in the DC bus and a WES of rating 20 kW is the source in the AC bus. The 10 kW FC system acts as the ancillary source on the DC bus. A battery system of 150 Ah and 400 V is employed in the AC subgrid as shown in Fig. 1. This helps in power management and voltage stabilization of the AC subgrid. The dynamic models of the PV and FC systems are realized as explained in [26, 27]. The PV and WES systems are controlled by MPPT techniques accomplished using a boost converter [28]. A voltage controller regulates the inverter of WES. The subgrids are combined using an ILC and a transformer. The configuration of the HMG is depicted in Fig. 1.

2.2 Control Techniques of FC and Battery

The FC system is comprised of a controlled boost converter. The controller regulates the current generation from FC as per the DC load demand when the load current (I_{DCL}) surpasses the current flowing through the PV system's converter (I_{PV}). The error between the I_{DCL} and the I_{PV} is the reference to the controller. When the power produced by the PV system goes beyond the demand, extra power is delivered to the AC subgrid.

The battery system consists of a bidirectional DC-DC (BDC) converter regulated by a voltage-current (V-I) controller. The outer loop of this controller

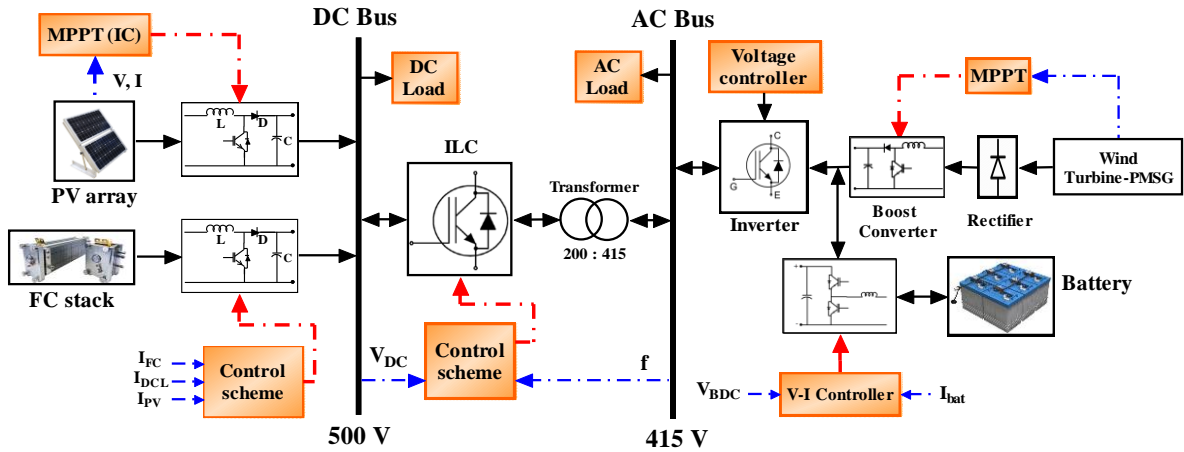

Fig. 1 Schematic representation of the system.

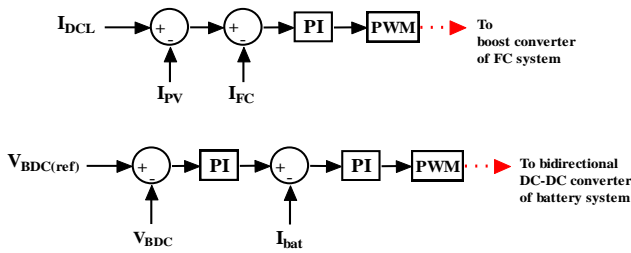

Fig. 2 Control techniques of FC and battery.

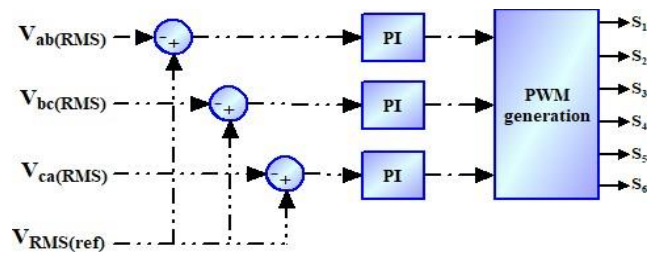

Fig. 3 Voltage controller of the inverter.

compares the output voltage of the BDC (V_{BDC}) with the set point of 800 V and the PI regulator calculates the reference current. The inner loop takes the current output of the BDC (I_{bat}) as the feedback and computes the duty cycle through a PI controller. This assists the energy management of AC subgrid and storing the excess power generated in both subgrids. The control schemes of the FC and battery system are illustrated in Fig. 2.

2.3 Controller of the Inverter of WES

The desired root mean square (RMS) voltage (415 V) is the reference and the actual RMS value of line voltage is taken as feedback. Three PI regulators are used. This control scheme is presented in Fig. 3.

2.4 Control Scheme of the ILC

In this control scheme, the error between normalized values of frequency (f) and the DC bus voltage (V_{DC}) are used to compute active power [2, 5]. The active and reactive power (P and Q) are calculated using (1) and (2).

$$f = f^* - aP \tag{1}$$

$$V_{AC} = V_{AC}^* - bQ \tag{2}$$

where a and b are the droop coefficients and are expressed as (3) and (4).

$$a = \frac{f_{max} - f_{min}}{P_{max}} \tag{3}$$

$$b = \frac{V_{AC(max)} - V_{AC(min)}}{Q_{max}} \tag{4}$$

Normalized voltage and frequency (V_{DCNZ} and f_{NZ}) are computed using (5) and (6).

$$V_{DCNZ} = \frac{V_{DC} - V_{DC}^*}{V_{DC}^*} \tag{5}$$

$$f_{NZ} = \frac{f - f^*}{f^*} \tag{6}$$

The normalization index NI can be calculated as (7). A PI controller is used to keep it minimal so as to stabilize the V_{DC} and the frequency.

$$NI = \frac{f_{NZ} - V_{DCNZ}}{2} \tag{7}$$

Based on the real and reactive power, the corresponding current signals are generated by using (8) and (9).

$$I_{d(ref)} = \frac{2P_{ref}}{3V_{AC}} \tag{8}$$

$$I_{q(ref)} = -\frac{2Q_{ref}}{3V_{AC}} \tag{9}$$

where f^* is the rated frequency, f_{max} and f_{min} are the maximum and minimum allowed frequency, respectively. V_{AC}^* is the rated AC bus voltage, $V_{AC(min)}$ and $V_{AC(max)}$ are the minimal and highest values of AC

bus voltage. $I_{d(ref)}$ and $I_{q(ref)}$ are the d and q axis current reference, respectively. P_{ref} and Q_{ref} symbolize active and reactive power reference, respectively.

The control technique employed for the ILC is depicted in Fig. 4. Based on the NI , the reference signal corresponding to the active power is computed.

3 Results and Discussion

The result analysis is presented in the absence and presence of a backup source (FC) in the DC subgrid. The control parameters of different control schemes are tabulated in Table 1. To investigate power management under varying conditions of the system, step variations are considered in the power generation and load demand. Simulation is accomplished in MATLAB/Simulink. The irradiance pattern and wind pattern chosen for the study are shown in Fig. 5.

3.1 In the Absence of the FC System (Case-1)

In this case, the PV system is the only source of energy in the DC bus. Any deficit or surplus in power on the DC subgrid will be managed via the ILC by exchanging power with the AC subgrid. The DC load demand, the PV power, and power flowing through the

ILC are depicted in Fig. 6.

Total load demand on both AC and DC buses, the power generated by the PV system and WES and battery power are shown in Fig. 7. The battery facilitates the energy balance of both subgrids.

The regulated voltage in DC and AC buses are depicted in Figs. 8(a) and 8(b), respectively. Voltage plots are characterized by fluctuations due to continuous power exchange through the ILC. However, the deviations are found to be acceptable as the controllers are carefully tuned.

3.2 In the Presence of FC System (Case-2)

The FC stack is included in the DC bus as the auxiliary source in this case. The current controlled FC system helps in matching the power amongst the DC load and the PV system when DC load demand exceeds the generation from the PV system. When the PV system produces surplus power, the surplus is transmitted to the AC bus through the ILC. This is depicted in Fig. 9. Any delay in power management caused due to the slow reaction of FC system will be managed by the battery system and hence proper power management can be achieved.

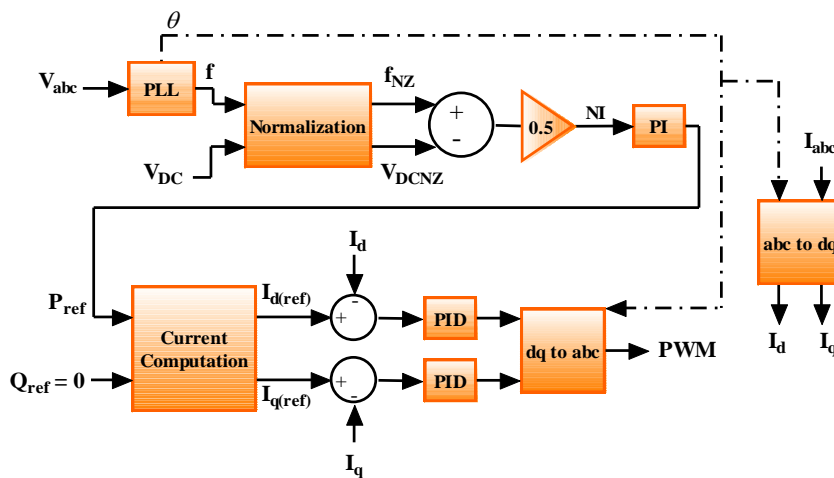

Fig. 4 The control scheme of ILC.

Table 1 Controller parameters.

Control strategy	Controller	K_P	K_I	K_D
FC controller	PI	0.0045	0.87	-
Control technique of the ILC	PI	7.5	120	-
Control strategy of the Inverter of WES	PID (P)	0.05	10	0.001
Battery controller	PID (Q)	0.2	25	0.01
MPPT of PV system	PI (3)	0.0005	0.055	-
MPPT of WES	PI (outer)	0.5	19	-
	PI (inner)	0.0001	0.35	-
	PI	500	0.0001	-
	PID	0.3	7.5	0.001

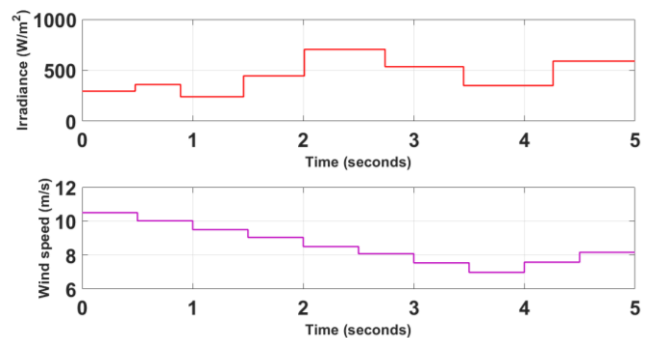

Fig. 5 Voltage controller of the inverter.

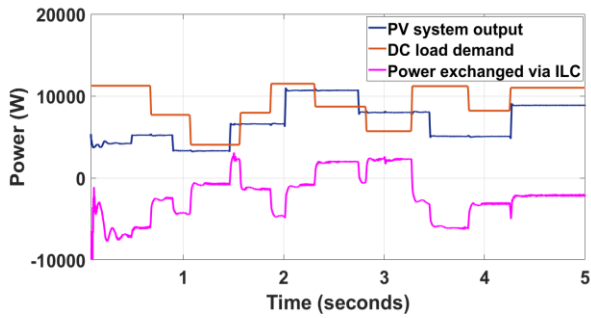

Fig. 6 DC load demand, the output of the PV system and power flowing through the ILC.

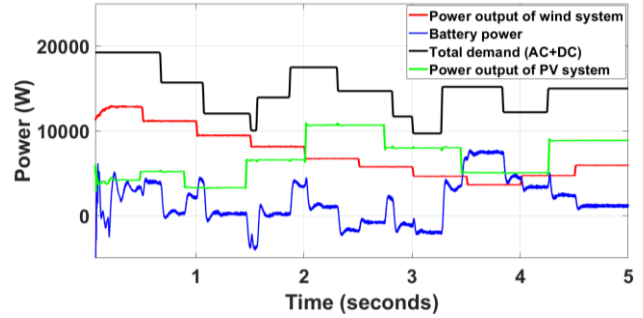

Fig. 7 PV power, the Power output of WES and battery with total load demand.

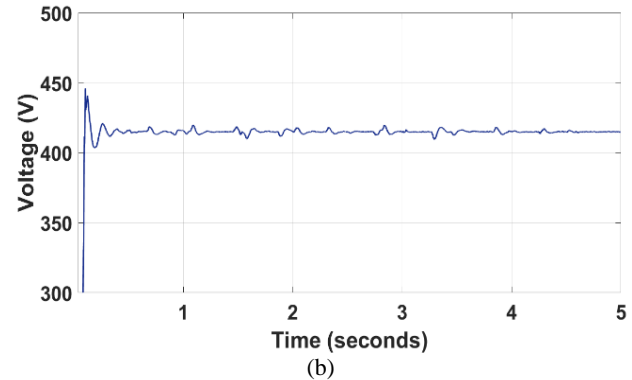
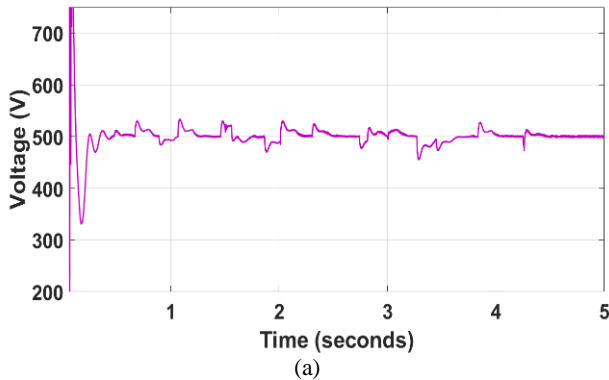

Fig. 8 The voltage of DC and AC buses in Case-1: a) DC bus voltage and b) RMS voltage of AC bus.

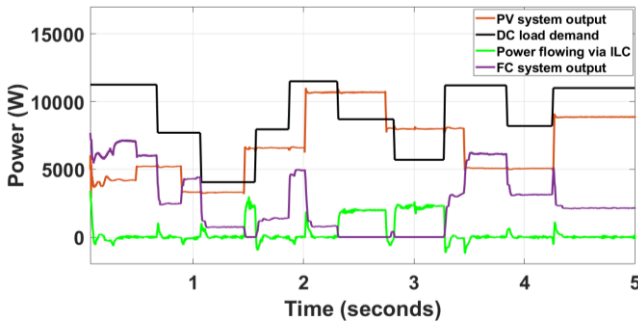

Fig. 9 DC load, PV power, FC system output and power through the ILC.

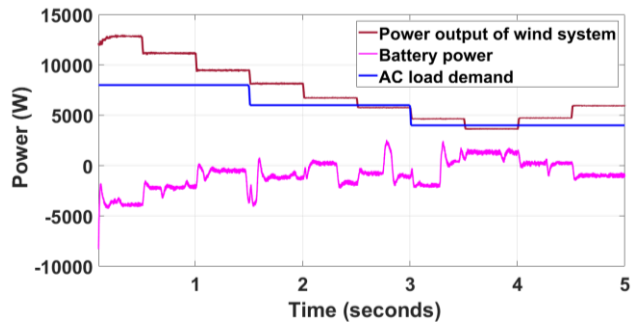

Fig. 10 PV power, the Power output of WES and battery with total load demand.

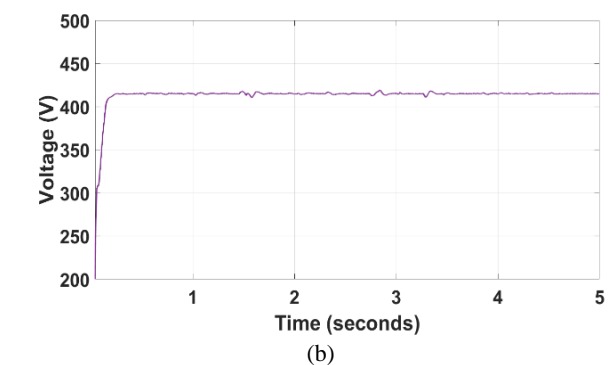
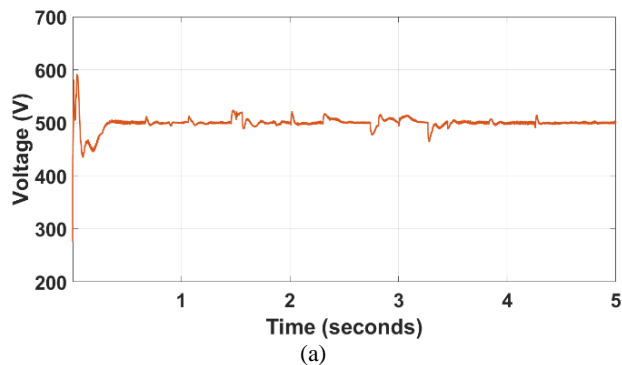

Fig. 11 The voltage of DC and AC bus in case-2: a) DC bus voltage and b) RMS voltage of AC bus.

The energy management among WES and AC load is aided by the battery, which is presented in Fig. 10.

The V_{DC} and AC bus voltage are shown in Figs. 11(a)

and 11(b), respectively. The battery helps in stabilizing the DC voltage input of the inverter of WES. Minimal variations are found in the plots of voltage. RMS

voltage has lesser fluctuations in Case-2 as compared to that of Case-1.

3.3 Comparative Analysis of Case-1 and Case-2

The V_{DC} and the f in the presence (Case-2) and absence (Case-1) of the FC system are depicted in Figs. 12 and 13, respectively. Any deviation in V_{DC} and frequency are compensated by corresponding changes in the active power based on the control scheme. By incorporating FC stack in the DC subgrid, the deviations in frequency and voltage are minimized as the power stress on the ILC is reduced.

The slow dynamic response of the FC system does not have a significant influence on the effective reduction in frequency and voltage deviations as the reduction is due to the reduced power exchange through ILC. The comparison between the two cases is presented in Table 2 in terms of maximum deviation in voltage and

frequency from corresponding reference values during variations in the generation and demand.

From Table 2, it is evident that the operation in the proposed configuration is desirable when the FC system is included in the DC bus.

When FC is present on the DC subgrid, the AC subgrid acts as a sink to the excess power from DC subgrid and the battery assists immediate power management. When FC is absent, the battery helps in the complete energy balance of both the subgrids. Hence, in Case-2, the stress on the battery is considerably less as shown in Fig. 14. This enhances the life span of the battery.

It is observable from Fig. 15(a) that the AC waveform is less distorted and the total harmonic distortion (THD) is in the acceptable limits as specified by the standards. The harmonic spectrum of the current in the AC bus is shown in Fig. 15(b).

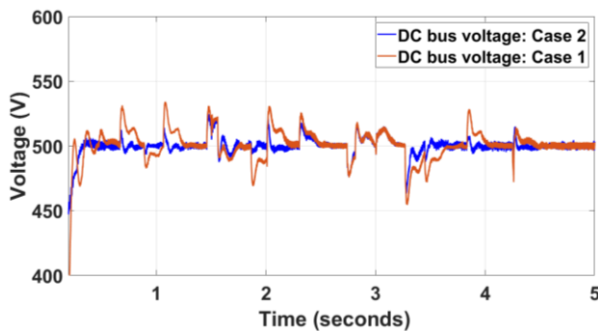

Fig. 12 DC bus voltage in Case-1 and Case-2.

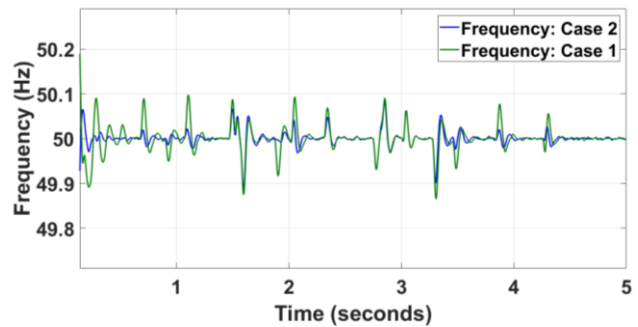

Fig. 13 Frequency in Case-1 and Case-2.

Table 2 Comparison of voltage and frequency deviations in both cases.

Parameter	Case-1	Case-2
The maximum deviation in DC bus voltage	44.4 V	35.5 V
The maximum deviation in frequency	0.13 Hz	0.11 Hz
The maximum deviation in RMS voltage of AC bus	5.6 V	4.7 V

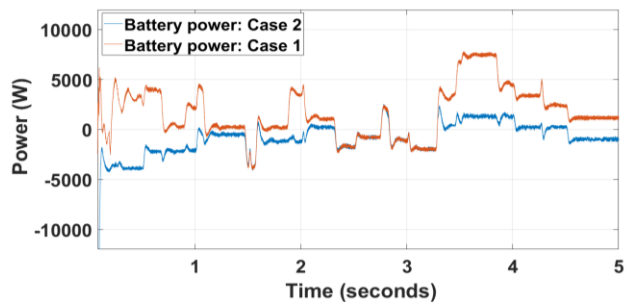
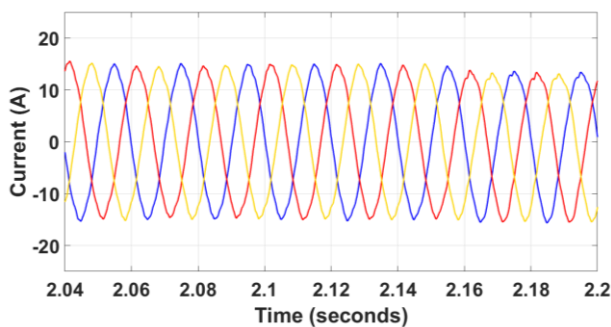
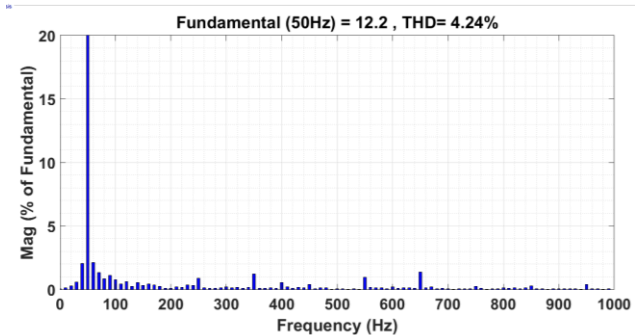

Fig. 14 Power output of the battery.



(a)



(b)

Fig. 11 AC bus current and harmonic spectrum: a) Current waveform and b) Harmonic spectrum.

4 Conclusions

This article presents an extensive study of an autonomous HMG comprising of PV, WES, and FC systems with battery. Control techniques are realized and verified during varying load demand. The control scheme of the ILC regulates the DC bus voltage, frequency and manages the power-sharing among the subgrids. The battery is responsible for the power management of the HMG and stabilization of the AC bus voltage. The key research findings are as follows.

- Proper voltage and power regulation are achieved in individual subgrids and also between two subgrids.
- The voltage and frequency deviations are minimized by incorporating the FC system on the DC bus. Hence it is recommended to integrate the FC system if the HMG operates in the proposed configuration.
- By using FC system on the DC bus, the stress on the battery reduces, which increases its life expectancy.

In the future, the impact of adaptive controllers on the HMG can be investigated.

References

- [1] X. Liu, P. Wang, P. C. Loh, "A hybrid AC/DC microgrid and its coordination control," *IEEE Transactions on Smart Grid*, Vol. 2, No. 2, pp. 278–286, 2011.
- [2] P. Wang, X. Liu, C. Jin, P. Loh, and F. Choo, "A hybrid AC/DC micro-grid architecture, operation and control," in *IEEE Power and Energy Society General Meeting*, pp. 1–8, 2011.
- [3] F. Nejabatkhah and Y. W. Li, "Overview of power management strategies of hybrid AC/DC microgrid," *IEEE Transactions on Power Electronics*, Vol. 30, No. 12, pp. 7072–7089, 2015.
- [4] C. Jin, P. C. Loh, P. Wang, Y. Mi, and F. Blaabjerg, "Autonomous operation of hybrid AC-DC microgrids," in *IEEE International Conference on Sustainable Energy Technologies (ICSET)*, pp. 1–7, 2010.
- [5] P. C. Loh, D. Li, Y. K. Chai, and F. Blaabjerg, "Autonomous operation of hybrid microgrid with AC and DC subgrids," *IEEE Transactions on Power Electronics*, Vol. 28, No. 5, pp. 2214–2223, 2013.
- [6] P. C. Loh, D. Li, Y. K. Chai, and F. Blaabjerg, "Autonomous control of interlinking converter with energy storage in hybrid AC–DC microgrid," *IEEE Transactions on Industry Applications*, Vol. 49, No. 3, pp. 1374–1382, 2013.
- [7] X. Jianfang, W. Peng, L. Setyawan, J. Chi, and C. F. Hoong, "Energy management system for control of hybrid AC/DC microgrids," in *IEEE Conference on Industrial Electronics and Applications (ICIEA)*, pp. 778–783, 2015.
- [8] N. Eghtedarpour and E. Farjah, "Power control and management in a hybrid AC/DC microgrid," *IEEE Transactions on Smart Grid*, Vol. 5, No. 3, pp. 1494–1505, 2014.
- [9] T. Ma, B. Serrano, and O. Mohammed, "Distributed control of hybrid AC-DC microgrid with solar energy, energy storage and critical load," in *IEEE Power Systems Conference (PSC)*, Clemson University, pp. 1–6, 2014.,
- [10] T. Ma, M. H. Cintuglu, and O. A. Mohammed, "Control of a hybrid AC/DC microgrid involving energy storage and pulsed loads," *IEEE Transactions on Industry Applications*, Vol. 53, No. 1, pp. 567–575, 2017.
- [11] E. Kabalcı, "An islanded hybrid microgrid design with decentralized DC and AC subgrid controllers," *Energy*, Vol. 153, pp. 185–199, 2018.
- [12] A. Gupta, S. Doolla, and K. Chatterjee, "Hybrid AC–DC microgrid: Systematic evaluation of control strategies," *IEEE Transactions on Smart Grid*, Vol. 9, No. 4, pp. 3830–3843, 2018.
- [13] J. Hu, Y. Shan, Y. Xu, and J. M. Guerrero, "A coordinated control of hybrid ac/dc microgrids with PV-wind-battery under variable generation and load conditions," *International Journal of Electrical Power & Energy Systems*, Vol. 104, pp. 583–592, 2019.
- [14] K. Sun, X. Wang, Y. W. Li, F. Nejabatkhah, Y. Mei, and X. Lu, "Parallel operation of bidirectional interfacing converters in a hybrid AC/DC microgrid under unbalanced grid voltage conditions," *IEEE Transactions on Power Electronics*, Vol. 32, No. 3, pp. 1872–1884, 2017.
- [15] J. Liu, M. J. Hossain, and J. Lu, "Switching performance optimization for a hybrid AC/DC microgrid using an improved VSG control strategy," in *IEEE Innovative Smart Grid Technologies-Asia (ISGT-Asia)*, pp. 1–5, 2017.
- [16] H. Peng, M. Su, S. Li, and C. Li, "Static security risk assessment for islanded hybrid AC/DC microgrid," *IEEE Access*, Vol. 7, pp. 37545–37554, 2019.
- [17] L. Jia, Y. Zhu, S. Du, and Y. Wang, "Analysis of the transition between multiple operational modes for hybrid AC/DC microgrids," *CSEE Journal of Power and Energy Systems*, Vol. 4, No. 1, pp. 49–57, 2018.
- [18] J. Huang, X. Zhang, and T. Zhang, "Transmission power analysis and control of the DC transformer in hybrid AC/DC microgrid," in *IEEE International Power Electronics Conference (IPEC-Niigata 2018-ECCE Asia)*, pp. 2980–2985, 2018.

- [19] S. Amirkhan, M. Radmehr, M. Rezanejad, and S. Khormali, "An improved passivity-based control strategy for providing an accurate coordination in a AC/DC hybrid microgrid," *Journal of The Franklin Institute*, Vol. 356, No. 13, pp. 6875–6898, 2019.
- [20] P. T. Baboli, M. Shahparasti, M. P. Moghaddam, M. R. Haghifam, and M. Mohamadian, "Energy management and operation modelling of hybrid AC–DC microgrid," *IET Generation, Transmission & Distribution*, Vol. 8, No. 10, pp. 1700–1711, 2014.
- [21] M. Hosseinzadeh and F. R. Salmasi, "Power management of an isolated hybrid AC/DC microgrid with fuzzy control of battery banks," *IET Renewable Power Generation*, Vol. 9, No. 5, pp. 484–493, 2015.
- [22] M. Hosseinzadeh and F. R. Salmasi, "Robust optimal power management system for a hybrid AC/DC micro-grid," *IEEE Transactions on Sustainable Energy*, Vol. 6, No. 3, pp. 675–687, 2015.
- [23] H. R. Baghaee, M. Mirsalim, G. B. Gharehpetian, and H. A. Talebi, "A decentralized power management and sliding mode control strategy for hybrid AC/DC microgrids including renewable energy resources," *IEEE Transactions on Industrial Informatics*, 2017.
- [24] M. H. Marzabali, M. Mazidi, and M. Mohiti, "An adaptive droop-based control strategy for fuel cell-battery hybrid energy storage system to support primary frequency in stand-alone microgrids," *Journal of Energy Storage*, Vol. 27, p. 101127, 2020.
- [25] G. Ding, F. Gao, S. Zhang, P. C. Loh, and F. Blaabjerg. "Control of hybrid AC/DC microgrid under islanding operational conditions." *Journal of Modern Power Systems and Clean Energy*, Vol. 2, No. 3, pp. 223–232, 2014.
- [26] J. N. Sabhahit, D. N. Gaonkar, and P. B. Nempu, "Integrated power flow and voltage regulation of stand-alone PV–fuel cell system with supercapacitors," *International Journal of Power and Energy Systems*, Vol. 37, No. 1, pp. 1–9, 2017.
- [27] M. Uzunoglu, O. C. Onar, and M. S. Alam, "Modeling, control and simulation of a PV/FC/UC based hybrid power generation system for stand-alone applications," *Renewable Energy*, Vol. 34, No. 3, pp. 509–520, 2009.
- [28] N. S. Jayalakshmi and D. N. Gaonkar, "Operation of grid integrated wind/PV Hybrid system with grid perturbations," *International Journal of Renewable Energy Research (IJRER)*, Vol. 5, No. 4, pp.1106–1111, 2015.



P. Bhat Nempu was born in Udupi, India in 1993. He obtained B.E. degree in Electrical and Electronics Engineering from Visvesvaraya Technological University, India and M.Tech. (Energy Management Auditing & Lighting) from the Department of Electrical and Electronics Engineering, Manipal Institute of Technology, India, respectively. He is currently a research scholar in the Department of Electrical and Electronics Engineering, Manipal Institute of Technology. His research area is operation and control of microgrids.



J. N. Sabhahit was born in Udupi, India in 1969. She obtained B.E. degree in Electrical Engineering from M.S.R.I.T., Bangalore, India, and M.Tech. (Power Systems) from the National Institute of Engineering, Mysore, India, respectively. She received her Ph.D. from the Department of Electrical and Electronics Engineering, National Institute of Technology, Karnataka, India. Now she is working as a Professor in the Department of Electrical and Electronics Engineering, Manipal Institute of Technology, India. She has published many papers in reputed international journals and conferences. Her research areas include power systems operation and control, modeling and control of microgrids, power electronics and control.



© 2020 by the authors. Licensee IUST, Tehran, Iran. This article is an open access article distributed under the terms and conditions of the Creative Commons Attribution-NonCommercial 4.0 International (CC BY-NC 4.0) license (<https://creativecommons.org/licenses/by-nc/4.0/>).